

sēco

**ACCESSORIES
INVEST IN THE BEST**



CATALOG

New Products



**Tri-Max®
Instrument Tripods**
(90550-WD, 90551-WD,
90553-WD)
Hardwood Tri-Max®
precision instrument tripod.

PAGE 42



Safety Lighted Utility Vest
(8565 series)
Retroreflective and Active Lightning
Features minimize injury risk by making
workers visible in dark or poorly lit
environments

PAGE 62



Mini 360 Prism and Kit
(6406-01 and 6406-02)
Lightweight and inexpensive, made to be set
up and left for extended periods

PAGE 33



Hand Level (4300-KR)
2-Power Stadia Hand Level

PAGE 55



**Backpack
Carrying System**
(D13035 series)
Easily carry all large
instrument containers.
Includes enhanced
visibility

PAGE 65



**Claw Cradle Pole Clamp System
Assembly for TSC7/Ranger7**
(5200-45, 5200-079, 5200-167)
Heavy duty claw cradle system with 6 tilt positions

PAGE 8



SK Leveling Rods
(7400-10, 7400-20, 7400-30)
Non-conductive lightweight
fiberglass leveling rods

PAGE 51



**Drone Ground Control
Targets** (6705-30)
Made in USA for all Survey Drone software

PAGE 15



**Copper-coated Mini-prism with 360° Rotation
& Magnetic attachment** (6605 series)
Monitor bridges, rail lines, buildings quickly and accurately

PAGE 37

Retro Reflective Survey Targets (6606 series)
Ideal for back sights, check shots, elevation references

Retro Reflective Target with 360° Rotation
(6604 series)
Twistable and rugged. Leave in place for extended use

Note on the Flags: All products are available worldwide. The US flag means that the product is shipped from the US warehouse only. The EU flag means that it can also be shipped from our European warehouse.



Inventory subject to change without notice. Refer to SECO's website at Surveying.com for the latest product information.



GNSS



Land Surveying



Construction Site Prep

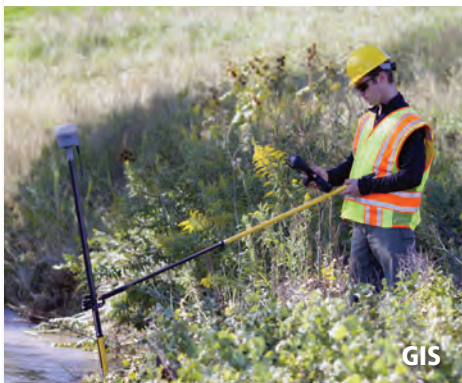

GIS



Mining, Tunneling,
Monitoring and Rail



Agriculture



Energy



Safety

CONTENTS

GNSS Accessories	5-14	Leveling Rods, Accessories and Brackets	48-51
Ground Control	15	Measuring Tapes, Rulers, Cases, Magnetic Locators and Gopher Pole	52-53
Vehicle Accessories	16-17	Stream Gauges and Supplies	54-55
Vials and Levels	18	Optical Instruments	56-57
Laser Scanner Accessories	19-21	Laser Detectors and Receivers	58-59
Robotics and Specialty Prism Poles	21-23	Bullseye Construction Accessories	59-60
Prism Poles and Accessories	23-27	Wall/Column Clamps and Brackets	60-61
Prism Pole Bipods & Tripods	28-29	ANSI/ISEA Class Safety Utility Vests	62-64
Prisms and Assemblies	30-34	Hydration Backpack, Bags and Cases	65-70
Prism Systems, Tilting, Mini, Sliding and Pin Pole Kits	35-36	Magnetic Nails	71
Monitoring Prisms and Accessories	37-39	Flagging Dispenser and Marker	71
Traverse Kits	40	Miscellaneous Field Accessories	72
Tribachs and Adapters	41	Rite in the Rain	73
Tri-Max Tripods	42-43	Index by Part Number	74-76
Instrument Tripod and Accessories	44-47	Index by Description	77-79

SECO MANUFACTURING

For decades, SECO Manufacturing Co., has stayed on the cutting edge of designing and manufacturing tools and accessories for surveying, construction, utilities and other industries that use GPS/GNSS technology.

From instrument tripods, and prism assemblies, to survey poles and leveling rods, SECO products are made to last no matter the field conditions. SECO also makes brackets and cradles for all the current handhelds on the market.

SECO enjoys a global reputation for innovation and quality because we control each phase of product manufacture. We maintain an on-site manufacturing facility featuring state-of-the-art equipment to make certain that all products are made to meet SECO's strict quality standards. SECO quality is so well recognized worldwide that many key surveying and construction manufacturers ask SECO to produce their own branded accessories. This has developed an important high-end OEM market, respected above the low cost / low quality manufacturers established in Asia. For years, the "Manufacturing by Seco" label has been recognized for quality that has never been surpassed.

SECO product managers are known for coming up with solutions for any kind of field requirement to meet customer needs. SECO products are available through dealers in almost every continent.

Precision manufacturing, quality focus, and skilled workmanship provide consistency to always meet and exceed customers' expectations. SECO's continued goal is to be the best accessories supplier for the surveying and construction markets. This ongoing mission ensures that investing in SECO brand products will remain the smartest investment for productivity and longevity in the field.

SECO, based in California, USA, with facilities in Redding, Tecate, CA and Mexico, controls all facets of its manufacturing business. SECO's 82,500 square-foot manufacturing plant in Redding houses our company headquarters, customer service team, engineering, research and development, and a complete manufacturing facility. The facilities include anodizing, electrostatic powder-painting, and silk-screening departments, as well as a state-of-the-art machine shop.

Rounding out the SECO inventory, we also offer entry-level third-party manufactured accessory products for those customers who do not have the budget or need for long-lasting SECO manufactured products.

Check out Surveying.com, follow us on Twitter, Facebook and LinkedIn, and contact SECO for all your field accessory needs!



The SECO facilities at Redding, CA.







Tripods: GNSS/MC

Standard and Heavy Duty, with telescoping legs



FEATURES & BENEFITS

- ▶ 5119-00 version offers dual graduations, collapsible center staff with a quick clamp and/or screw clamp (see table) and includes removable 5/8 x 11 adapter, and an on-board compass
- ▶ Both the 5115-00-XXX series and the 5119 series have a fixed-height, 2-meter center staff that rotates 360° for calibrating the included 8-minute vial
- ▶ All aluminum hardware is anodized black for long life
- ▶ 5119-10 features large telescoping legs (1.25 to 1.5 inch diameters) feature adjustable handle levers on the leg pivots and a large 6-inch diameter round head which easily holds lasers or robots
- ▶ All three tripods feature extendable electrostatically powder painted legs and include replaceable points

PART NO.	LOCKING	HEIGHT	COLLAPSES	COLOR	WEIGHS	
5115-00-FLY	Quick Clamp	2 m	2 m	Flo Yellow	15.00 lb (6.80 kg)	
5115-00-YEL	Quick Clamp	2 m	2 m	Yellow	15.00 lb (6.80 kg)	
5119-10-FLY	Screw Clamp	1.5, 1.8, 2 m	55 inches (1.4 m)	Flo Yellow	20.00 lb (9.07 kg)	
5119-10-YEL	Screw Clamp	1.5, 1.8, 2 m	55 inches (1.4 m)	Yellow	20.00 lb (9.07 kg)	
5119-00-FLY	Quick Clamp/Screw Clamp	1.5, 1.8, 2 m	50 inches (1.27 m)	Flo Yellow	15.00 lb (6.80 kg)	
5119-00-FOR	Quick Clamp/Screw Clamp	1.5, 1.8, 2 m	50 inches (1.27 m)	Flo Orange	15.00 lb (6.80 kg)	
5119-00-YEL	Quick Clamp/Screw Clamp	1.5, 1.8, 2 m	50 inches (1.27 m)	Yellow	15.00 lb (6.80 kg)	

Network Adapters

Professional Stainless Steel 303 CORS monument adapters







Note: Vial not included. See page 16.



FEATURES & BENEFITS

- ▶ Adapters in the 2072-Series have 3.20-in (8.19-cm) diameters and overall heights of 3.036-in (7.71-cm)
- ▶ Adapters are leveled by three screws with a tilt range +/- 7°
- ▶ Made of 303 SS and brass
- ▶ Includes a removable brass 5/8 x 11 male stud that is adjustable in azimuth and held in location by two set screws
- ▶ The axis height is engraved on the outside of the monuments
- ▶ Height above the pivot point to stud shoulder is 1.37-in (3.50-cm)
- ▶ Height below the brass 5/8 stud to shoulder is 0.463-in (1.18-cm)

PART NO.	FITS	COMPATIBLE WITH	WEIGHS	
2072-30	MPT 1-1/2 x 11-1/2 TPI	1.5-inch pipe	5.50 lb (2.50 kg)	
2072-31	MPT 2 x 11-1/2 TPI	2-inch pipe	6.60 lb (3.00 kg)	
2072-32	MPT 3-1/2 x 8 TPI	3-inch pipe	6.90 lb (3.10 kg)	
2072-33	MPT 5/8 x 11 TPI	any female 5/8x11	6.20 lb (2.80 kg)	
2072-050	40-minute leveling vial	any female 5/8x11	0.30 lb (0.14 kg)	

Radio Antenna Tripod



FEATURES & BENEFITS

- ▶ Radio antenna tripod with antenna mast gets your radio antenna to the desired height
- ▶ Telescoped to 7.5-ft (2.3-m) and the tripod can be set to 5.5-ft (1.7-m) for a total elevation of 13-ft (4-m)

- ▶ Aluminum with a male 5/8 x 11 tip
- ▶ Hardwood/Fiberglass tripod is SECO's 5302-13-ORG
- ▶ Aluminum tripod is SECO's 5301-21-ORG

- ▶ The antenna mast can be purchased separately to convert your own heavy-duty tripod as well
- ▶ Weighs 19.00 lb (8.62 kg)

5561-20 — Radio Antenna Mast Assembly
 5300-11 — Hardwood/Fiberglass
 5300-12 — Aluminum (shown)



Hands Free Tablet Harnesses

Provide Secure Hands-free Operation During Field Use



5200-95



5200-96

FEATURES & BENEFITS

- ▶ When purchased with the correct tablet bracket, each of these harnesses provide reliable hands-free operation
- ▶ Over one shoulder model allows for easy on/off operation (5200-95)
- ▶ Two-shoulder model allows for tighter movement and helps reduce fatigue for day-long operation (5200-96)
- ▶ Ball-and-Socket designs allows a tablet to be in multiple positions and very easy to adjust

- ▶ Mounts to tablet bracket using standard 1-1/2 inch ram ball connection
- ▶ 5200-95 and -96 come with 1-1/2 inch RAM ball
- ▶ Mount is made from a 0.080-inch (2.03-mm) black powder-coated aluminum sheet metal
- ▶ Weights: 5200-95 1.95 lbs, 5200-96 1.9 lbs
- ▶ Tablet brackets allow all ports, connections, and antenna to be accessible with the bracket attached

APPLICATIONS

- ▶ GNSS/Robotic surveying
- ▶ Construction Layout
- ▶ Road and highway surveys
- ▶ GIS Surveys

FOR TABLETS THAT HAVE THE QUICK RELEASE BRACKET ATTACHED

BRACKET PART NO.	FIT	
5200-39-051	Yuma 2/Yuma 7/T-7	
5200-40-051	Kenai/T-10	
5200-42-051	FZ-G1 With Radio	
5200-44-051	TSC7/Ranger7	

COMPLETE WITH TABLET BRACKET AND RAM LINK

BRACKET PART NO.	FIT	
5200-29-051	FZ-M1	
5200-30-051	FZ-G1/CS35	
5200-31-051	Getac T800	
5200-35-051	Tesla, Mesa 2/3/FC 5000/RT3/4	
5200-37-051	Yuma 2, T-7, 7" Rugged Tablet	
5200-38-051	Kenai, 10" Rugged Tablet	
5200-41-051	FZ-G1 with Radio	
5200-44-051	TSC7/Ranger7 (RAM 1.5 inch)	

Note: Tablet not included. Brackets sold separately.



5200-39-052

5200-95 — One Shoulder Tablet Harness
 5200-96 — Two Shoulder Tablet Harness
 5200-39-052 — Quick Release Bracket Adapter



Pole Clamp: Ball and Socket Tablet

Virtually unlimited positions on the pole keeps the glare off the collector







5200-35

FEATURES & BENEFITS

- ▶ Pole Clamp locks securely to the pole, no slipping!
- ▶ All ports, connections, and camera are accessible and usable with the bracket attached

- ▶ Easy "snap in/out" design holds the tablet securely
- ▶ Compatible with add-on keyboard and extended battery
- ▶ Made from a single, solid 0.080 inch (2.03 mm) aluminum sheet metal

- ▶ Features ram ball links which allow many positions
- ▶ The 5200-35 features a 1-inch ram ball – the Ball-and-Socket versions allow the data collector to be in more positions

PART NO.	WORKS WITH	
5200-30	Panasonic FZ-G1/Leica CS35 (Not for Radio Models)	
5200-31	Getac T800	
5200-35	Tesla , Mesa 2/3, FC 5000, RT3/4	
5200-41	FZ-G1/CS35 with Radio, Ram	

Cradles: Claw Ball and Socket

Design your own custom solution with one bracket and one cradle



5200-16-050



5200-29-050

FEATURES & BENEFITS

- ▶ These Claw™ clamps are made of durable anodized aluminum
- ▶ The Claw technology allows maximum tightening without crushing

- ▶ Features a 1-inch ram ball – the Ball-and-Socket versions allow the data collector to be in more positions

- ▶ Use with 5200-201 Ball and Socket Link, and 5200-160 or 5199-052 Pole Clamp

PART NO.	WORKS WITH	TYPE	
5200-16-050	TSC3, Ranger 3 Series	Claw	
5200-17-050	Mesa/Tesla	Snap In/Out	
5200-29-050	Panasonic FZ-M1, B2	Snap In/Out	

Pole Clamp: Tablet Quick Release

Secure connection to your survey pole and tablet during field use







5200-33

FEATURES & BENEFITS

- ▶ Pole Clamp locks securely to the pole, no slipping!
- ▶ Tilting Feature with three positions, +10, +30 or +50 degrees

- ▶ Quick Release from Pole Clamp for taking photos, etc. and also allows Landscape or Portrait orientation of the Display
- ▶ All ports, connections, and camera are accessible and usable with the bracket attached

- ▶ Easy "snap in/out" design holds the tablet securely
- ▶ Compatible with add-on keyboard and extended battery
- ▶ Made from a single, solid 0.080 inch (2.03 mm) aluminum sheet metal, powder-coated black

PART NO.	MODEL	TABLET SIZE	
5200-32	Panasonic FZ-M1	7 inch (17.78 cm) tablet	
5200-33	Panasonic FZ-G1/Leica CS35	10 inch (25.4 cm) tablet	
5200-41	FZ-G1 with Radio	10 inch (25.4 cm) tablet	
5200-42	Panasonic FZ-G1/Leica CS35 with Radio	10 inch (25.4 cm) tablet	
5200-43	T-10 with Radio Quick Release	10 inch (25.4 cm) tablet	

Claw Cradles: Quick Release

Design your own custom solution with one bracket and one cradle



FEATURES & BENEFITS

- ▶ The Claw™ is a clamping system featuring an innovative clamping device that keeps your expensive data collecting hardware snug on the pole

- ▶ where it belongs without crushing it
- ▶ The Claw cradles and clamps are made of durable anodized aluminum for years of trouble-free use in the field

- ▶ Quick-Release cradles plug directly in to Quick Release Pole Clamps

PART NO.	WORKS WITH	
5200-050	FC 2500	
5200-058	FC-200, FC-250	
5200-059	Nomad 800-900 Series	
5200-062	Carlson Surveyor, Surveyor +, GIS-1	
5200-064	Geo 6000 Series, Geo 7X	
5200-065	TSC3, Ranger 3 Series	
5200-070	Juno 5 / Juno T41 Series, Slate	
5200-072	Mesa Tesla	
5200-073	Archer 2, Mini2, FC 500	
5200-074	Allegro 2, Allegro 3, Surveyor 2	
5200-075	Nautiz X8, Nautiz X9	
5200-076	Panasonic Toughpads FZ-M1, B2 (Not Claw – “Snap in”)	
5200-077	Mesa 2/3, FC 5000, RT3/4 (Not Claw – “Snap in”)	

Claw Cradle Assembly for TSC7/Ranger7



FEATURES & BENEFITS

- ▶ New Claw design for the TSC7/ RANGER7 Controller
- ▶ 5200-079 with 5200-167 is a complete assembly 5200-45
- ▶ The 5200-45 is also compatible with the TSC3/Ranger3 handheld, for those wanting a more heavy-duty claw-clamp solution with more tilt positions on the pole
- ▶ Includes replaceable silicone pads that hold the controller securely
- ▶ This new design utilizes our stronger quick release that

- we use on heavy tablet pole brackets.
- ▶ All machined anodized aluminum and stainless steel construction
- ▶ Pole Clamp fits all standard 1.25" diameter poles
- ▶ Pole clamp has six tilt positions from vertical to horizontal of the display
- ▶ Assembly weighs only 0.95 lbs, 0.43kg
- ▶ 5200-079 weighs 0.4 lbs, 0.18kg
- ▶ 5200-167 weighs 0.55 lbs, 0.25kg

- 5200-45 — Claw Cradle Pole Clamp System
- 5200-079 — Claw Cradle
- 5200-167 — Pole Clamp

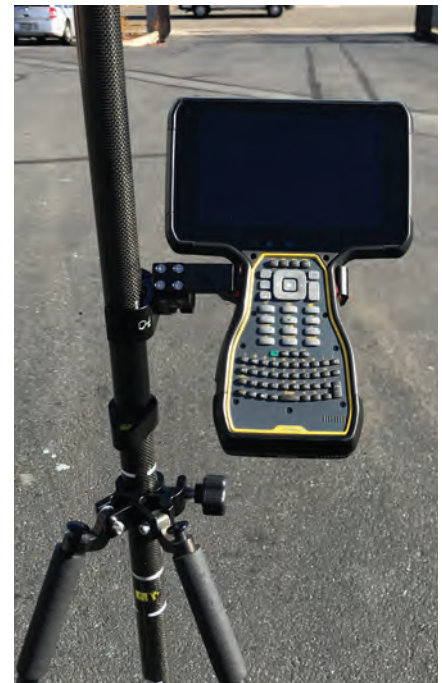

Ball-and-Socket and Claw Accessories

Perfect for creating a custom solution

- ▶ Fits any standard instrument tripod
- ▶ Use with a 5200-201 Ball-and-Socket Link and a Ball-and-Socket Cradle (designed for your data collector) for a complete system



5199-051 — Tripod Mount

- ▶ Fits any standard instrument tripod
- ▶ Use with a 5200-201 Ball-and-Socket Link and a Ball-and-Socket Cradle (designed for your data collector) for a complete system



5199-054 — Suction Cup (temporary mount)

- ▶ Use the Ball-and-Socket Link for your custom solution
- ▶ Fits the 1-inch ram ball on cradles and clamps



5200-201 — Ball-and-Socket Link

- ▶ Mount your data collector or controller to this ball clamp and the handle bars of your ATV



5199-050 — ATV Ball Clamp

- ▶ Pole Clamp with 1-inch (32 mm) Ram Ball
- ▶ Fits poles with an outside diameter of 0.75-inches to 1.5-inches



5199-052 — Ram Ball Clamp Mount

Pole Clamps and Cradles

Design your own custom solution with clamp and cradle

FEATURES & BENEFITS

- ▶ Original Open-Style Pole Clamp technology for a complete solution
- ▶ Use a Claw Quick-Release cradle or clamp for a complete solution

- ▶ Made of black anodized aluminum
- ▶ Depressing the quick-release button will allow the Claw Quick-Release cradle or clamp to rotate in to a comfortable position for reading the data

- ▶ collector or controller
- ▶ Features a quick-release button and a stainless steel clamp screw that attaches to the pole
- ▶ Designed for standard poles or rods with a 0.75 to 1.25-inch OD



5198-056



5198-153



5200-160



5198-073

PART NO.	Quick Release Open-Style Clamps (for 1.25-inch OD pole)	
5198-052	Plain	
5198-054	40-minute Vial	
5198-055	Compass	
5198-056	Compass and 40-minute Vial	
5198-059	0.15 x 0.92-inch Slot	
5198-152	For 1.5-inch OD Pole	
5198-153	Battery Slot with Quick Release	
PART NO.	Claw Ball-and-Socket Clamps (for 1.25-inch OD pole)	
5200-160	Plain with 1" Ball	
5200-164	With Compass	
5200-165	With 40-minute Vial and Compass	
5200-166	Plain with 1.5" Ball	
PART NO.	Claw Quick Release Clamps (for 1.25-inch OD pole)	
5200-150	Plain	
5200-151	With 40-minute Vial	
5200-152	With 20-minute Vial	
5200-154	With Compass	
5200-155	With 40-minute Vial and Compass	
PART NO.	Quick Release Cradles	
5198-073	Nautiz N7, DAP 9800, SDR33, Titan	
5198-081	PDA	

Quick Release Cradle



5198-086

FEATURES & BENEFITS

- ▶ 5198-086 cradle requires Leica pole bracket, any model. This modifies the Leica pole bracket to work with SECO poles.

- ▶ Requires a SECO quick-release pole bracket

5198-086 — Quick Release Cradle for Leica Pole Bracket



Tripod Data Collector Brackets

- ▶ The open clamp attachment allows quick and easy connection to the pole; it connects to 1-to-1.25-inch (25.4 to 31.8-mm) OD poles
- ▶ Brass male 5/8 x 11 captive stud is easily removed for direct attachment of the radio antenna to the bar
- ▶ Includes a non-slip Velcro® cable strap to help manage radio cables
- ▶ Weighs 0.22 lb (0.10 kg)

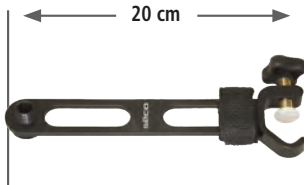

2133-03 — Antenna Bracket



- ▶ Bracket holds a radio antenna securely to a tripod leg
- ▶ The heavy-duty bracket makes plumbing the antenna easy
- ▶ Fits all full-size and heavy-duty tripods and uses a 1/2-inch long, 5/8 x 11 male stud to secure the antenna or extension (tripod sold separately)
- ▶ Can be used with the SECO Six Foot Snap-Lock Radio Antenna Pole (5139-02, page 14) or any extension with a male/female 5/8 x 11 connection
- ▶ Weighs 1.55 lb (0.70 kg)



2133-05 — Radio Antenna Bracket for Tripod



- ▶ Easy installation and removal
- ▶ Adjust location on tripod leg for your convenience
- ▶ Powder painted aluminum
- ▶ Weight 0.40lbs / 0.18kg



5196-22 — Tripod Hook
TSC7 / Ranger 7



- ▶ Designed to fit precisely on the back of the controller
- ▶ Works with most heavy-duty tripods that feature a connecting bar on the hinge area



Tripod Hook Brackets Designed for

- 5196-17 — Nomad
- 5196-18 — TSC3 or Ranger 3
- 5196-19 — Mesa Tesla
- 5196-20 — Archer 2



- ▶ Holds the Allegro 1-3, Archer®, Explorer, Recon® or Jett®•ce



5196-07 — Tilted Bracket



- ▶ Easily holds a laptop computer
- ▶ Measures: 13 x 10.25 in (33 x 26.04 cm)



5196-02 — Laptop Bracket



Two-Piece GNSS Rover Rods

Two-piece is easy to set up and convenient to store and transport



FEATURES & BENEFITS

- ▶ Lightweight two-piece rover rods come in aluminum or carbon fiber and feature 5/8 x 11 tips (5125-01-YEL features a quick-release adapter) and 40-minute vials
- ▶ Outer graduations options are 10ths/100ths (GT), metric (GM) or Quick Release (QR)
- ▶ 5125-06-YEL and 5128-08 feature a cable management slot measuring 0.625 x 1.6-in to hide cables

▶ Order 8162-00-ORG for carrying case

PART NO.	POLE	TIP	CABLE SLOT	OUTER GRADS	LENGTH	WEIGHS
5125-00-YEL	Aluminum	5/8 x 11	No	10ths/100ths (GT)	2 meters	3.00 lb (1.36 kg)
5125-01-YEL	Aluminum	Quick Release	No	None	2 meters	3.00 lb (1.36 kg)
5125-06-YEL	Aluminum	5/8 x 11	Yes	10ths/100ths (QR)	2 meters	3.00 lb (1.36 kg)
5128-00	Carbon Fiber	5/8 x 11	No	10ths/100ths (GT) or Metric (GM)	2 meters	1.42 lb (0.64 kg)
5128-08	Carbon Fiber	5/8 x 11	Yes	10ths/100ths (GT, QR)	2 meters	1.42 lb (0.64 kg)

Prism Adapters, Tips and Topo Shoes

- ▶ Adapts Swiss-style snap-on prisms to 5/8 x 11 tribrach adapter or prism pole
- ▶ Weighs 0.06 lb (0.03 kg)



2080-SS — Wild Prism Adapter
2080-00 — Wild Prism Adapter

- ▶ 5/8 x 11 Female to 1/4 x 20 Female Adapter
- ▶ 5/8 x 11 Male to 1/4 x 20 Male Adapter
- ▶ Weighs 0.20 lb (0.09 kg)



2131-00 — Prism Pole Adapter - Male
2131-01 — Prism Pole Adapter - Female

- ▶ The Delrin® Adapter can be used when you want to increase the outside diameter (OD) of a pole from 1-inch to 1.25-inches or if you have a 1 inch OD pole and want to use a Claw™ pole clamp
- ▶ Can be used with Quick-Release Claw Cradles and Clamps or the Ball-and-Socket Claw Combo
- ▶ Weighs 0.03 lb (0.01 kg)



- ▶ 5/8 x 11 Double Male Adapter
- ▶ Weighs 0.06 lb (0.03 kg)



5180-00 — Double Male Adapter

- ▶ 5/8 x 11 Double Female Adapter
- ▶ Weighs 0.08 lb (0.04 kg)



5181-00 — Double Female Adapter

D11145 — Delrin 1-inch Pole Claw Clamp Adapter

Telescopic Carbon Fiber Rover Rods

Carbon fiber rover rods are 30% lighter

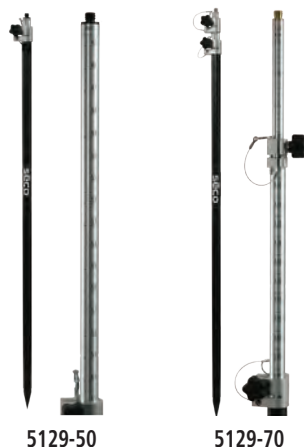

FEATURES & BENEFITS

- ▶ Designed so the GNSS surveyor has all the features needed in a single rod
- ▶ Zero height, reads direct
- ▶ The included pin can lock the length of the rod at set points
- ▶ TLV™ locking mechanism comes standard

- ▶ Carbon fiber makes these rods 30% lighter
- ▶ Order 8160-00-ORG for carrying case

PART NO.	GRADS	LENGTH	Outer Grads	PIN LOCKING	WEIGHS
5129-50	Dual (10ths/2 mm)	4.48 ft (1.4 m) - 8.14 ft (2.45 m)	10ths/100ths (GT)	1.8 m, 2 m, 2.2 m	2.30 lb (1.05 kg)
5129-51	Metric/2 mm	4.48 ft (1.4 m) - 8.14 ft (2.45 m)	None	1.8 m, 2 m, 2.2 m	2.30 lb (1.05 kg)
5129-70	Dual (0.05 ft/cm)	4.69 ft (1.43 m) - 11.7 ft (3.57 m)	None	Every 20 cm	3.30 lb (1.50 kg)
5129-71	Metric	4.69 ft (1.43 m) - 11.7 ft (3.57 m)	None	Every 20 cm	3.30 lb (1.50 kg)

Snap-Lock Rover Rods

Easy set up



FEATURES & BENEFITS

- ▶ Includes a one-piece design and two locking systems for stability
- ▶ Zero height, reads direct
- ▶ The snap lock prevents slippage and the compression lock

centers the telescopic inner pole and maintains straightness

- ▶ Telescoping rods include standard locking lengths and also have OPTIONAL outer graduations in metric (GM), 10ths/100ths (GT)

- ▶ Your choice of either aluminum or carbon fiber rod includes a 40-minute vial
- ▶ Order 8160-00-ORG for standard case
- ▶ Order 8151-02-FLY system bag (tripod or bipod)

PART NO.	POLE	OPTIONAL OUTER GRADS	LOCKING LENGTHS	WEIGHS	
5125-20-FLY	Aluminum	10ths/100ths (GT) or Metric (GM)	2 m	2.30 lb (1.05 kg)	
5125-20-YEL	Aluminum	10ths/100ths (GT) or Metric (GM)	2 m	2.30 lb (1.05 kg)	
5125-22-FLY	Aluminum	10ths/100ths (GT)	2, 1.8, 1.6 m	2.30 lb (1.05 kg)	
5128-20	Carbon Fiber	10ths/100ths (GT), Metric (GM)	2 m	1.60 lb (0.73 kg)	
5128-22	Carbon Fiber	10ths/100ths (GT) or Metric (GM)	2, 1.8, 1.6 m	1.60 lb (0.73 kg)	
5128-24	Carbon Fiber	Standard only	1.8, 1.6 m	1.60 lb (0.73 kg)	

Quick Change Prism Poles

Vials are on the locks, out of the way of instruments on the pole



FEATURES & BENEFITS

- ▶ Compatible with all targets, prisms, and GNSS antennas
- ▶ Using adapters, any of the poles in this series can be used for GNSS, robotics or total station surveys

- ▶ Metric Centimeter Graduations
- ▶ Quick conversion to another application by changing adapters (sold separately, see below)
- ▶ TLV™ (Twist-Lock with Vial) locking mechanism includes a

- 40-minute vial
- ▶ Available with locking pin & holes (the locking system guarantees no slipping of the sections)
- ▶ Carbon fiber and aluminum models offered

PART NO.	GRADUATED LENGTH	OUTER POLE	LOCKING PIN	ADAPTER INCLUDED	
5527-10	1.33 to 2.20 m	Aluminum		2090-12	
5527-11	0.50 to 0.70 m	Aluminum		2090-12	
5527-13	1.33 to 2.20 m	Carbon Fiber	@ 1.4, 1.6, 1.8, 2.0, 2.2M	2090-12	
5527-15	1.51 to 2.60 m	Aluminum		2090-12	
5527-16	1.51 to 2.60 m	Carbon Fiber	@ 1.8, 2.0, 2.2, 2.4, 2.6M	2090-12	
5527-17	1.58 to 3.60 m	Carbon Fiber	@ 1.8, 2.0M	2090-12	
5527-20	1.58 to 3.60 m	Aluminum		2090-12	
5527-22	1.58 to 3.60 m	Carbon Fiber	@ 1.8 to 3.6M every .2M	2090-12	
5527-30	1.65 to 4.65 m	Aluminum		2090-12	

Aluminum Pole Series with Locking Pins, Adapter

- ▶ Extends to 2.6M
- ▶ 0 Height, graduated in centimeters
- ▶ Locking pin holes at 1.8M, 2.0M, 2.2M, 2.4M, 2.6M
- ▶ 40' Vial
- ▶ Weight 3.15lbs (1.43kg)



- ▶ Extends to 8.5ft
- ▶ 135MM Height, graduated in centimeters and .01ft
- ▶ Locking pin holes at 6.5FT, 7.0FT, 7.5FT, 8.0FT, 8.5FT
- ▶ 40' Vial
- ▶ Weight 3.15lbs (1.43kg)



- ▶ Adapts Swiss-style prism poles to 5/8 x 11
- ▶ Weighs 0.06 lb (0.03 kg)



Can easily be converted to different heights by using one of our Quick Change Pole Height Adapters

Can easily be converted to different heights by using one of our Quick Change Pole Height Adapters

5512-13-FLY-GM — GNSS Model

5512-14-FOR-GT — Robotic Model
5512-14-FOR-GM — Metric Robotic Model

2090-00 — Wild Prism Pole Adapter

Accessories for Robotics Gear

- ▶ 5/8 X 11 aluminum prism height adapters allow the base pole to be used with other manufacturers' 360° prisms



- 2090-01 — For Topcon Users w/ 77 mm Prism
- 2090-02 — For Leica Users w/86 mm Prism
- 2090-04 — Users w/115 mm Prism
- 2090-06 — Convert Robotics to GNSS Pole (not shown)
- 2090-07 — For Topcon ATP1/2 with 50 mm Prism



- ▶ This lightweight bipod is used to keep a GNSS or robotic pole off the ground when not in use
- ▶ Weighs 0.90 lb (0.41 kg)



5217-15-ABK — 12 inch Open Clamp Bipod 

360° Robotic Prism Assembly

Copper-coated 35 mm prisms



FEATURES & BENEFITS

- ▶ Includes six 35 mm prisms
- ▶ 0 offset
- ▶ 77 mm prism height
- ▶ Copper-coated for moisture prevention
- ▶ Protective urethane bumper in yellow
- ▶ Designed for Topcon®

6401-00-YEL — 360° Robotic Prism Assembly 

GNSS Accessories and Adapters

Converts any GNSS receiver or prism with 5/8 x 11 threads to a Quick Release

- ▶ Adapter features a female 5/8 x 11 quick release tip
- ▶ Made of anodized aluminum or optional Stainless Steel version
- ▶ Adds 23.8-mm (.937 inches) to length of rod
- ▶ Weighs 0.05 lb (0.02 kg)



- 5187-00 — GNSS Quick-Release Adapter 
- 5187-00-SS — GNSS Quick-Release Adapter (Stainless Steel) 

- ▶ Use with GNSS Quick-Release Adapter (5187-00)
- ▶ Made of anodized aluminum or optional Stainless Steel version
- ▶ Adapter adds 76.22-mm (.937 inches) to the pole length
- ▶ Weighs 0.14 lb (0.06 kg)



- 5111-00 — GNSS Quick-Disconnect Adapter 
- 5111-00-SS — GNSS Quick-Disconnect Adapter (Stainless Steel) 

GNSS Accessories and Adapters cont.

Converts any GNSS receiver or prism with 5/8 x 11 threads to a quick release

- ▶ Anti-rotation quick-release assembly
- ▶ Heavy-duty construction, will hold up to 20 lb (9.00 kg)
- ▶ Short height, only 60 mm (2.5 inches)
- ▶ Constructed of quality stainless steel and aluminum
- ▶ Easy to operate, push button release
- ▶ Includes one (1) 5111-04-051
- ▶ For extra 5111-04-051, order separately
- ▶ Weighs 0.35 lb (0.16 kg)



5111-04 — 60 mm Anti-Rotation Quick Release 
5111-04-051 — Male 5/8 

- ▶ Adapter has male 5/8 x 11 threads
- ▶ Weighs 0.08 lb (0.04 kg)



5113-012 — GNSS Quick-Release Tip 

- ▶ Designed to hold on to pipes, flip the switch to release its hold on metal surfaces
- ▶ Holds up to 132.20 lb (60.00 kg)
- ▶ Weighs 2.15 lb (0.98 kg)



5114-052 — Switchable Kelly Magnet Mount 

- ▶ Used to elevate a radio antenna to 6 feet plus the height of the tripod setup
- ▶ Snap locks into a fixed length of 6-feet (1.8-m)
- ▶ Collapses to 41.5-inches (1-meter)
- ▶ Includes a 3.5-inch (8.89 cm) OD plate adapter (5182-002) to attach to any 5/8 x 11 tripod heads
- ▶ Available in standard yellow of fluorescent yellow
- ▶ Weighs 1.40 lb (0.62 kg)



5139-02-FLY — 6 Foot Snap-Lock Radio Antenna Pole 

- ▶ All-Terrain Rover Rod "Big Wheel"
- ▶ Measures 19 x 1-5/8-inch (48.26 cm x 3.81 cm)
- ▶ Rod and Bipod are not included with Wheel
- ▶ Perfect for RTK profiling
- ▶ Weighs 3.80 lb (1.72 kg)







5125-056 — All Terrain Wheel 

Add Rover top section:
5125-057-FLY — Aluminum Rod 
5128-052 — Carbon Fiber Rod 

- ▶ The 5114-series allows quicker attachment of the GNSS antenna
- ▶ The 5114-10 is an extra-tall mag mount for use when attaching GNSS receivers with downward antennas
- ▶ Both magnets have a 3.5-inch (8.89cm) diameters (5114-050 and 5114-051)
- ▶ Each single has 120 lb. of pull on 1/2" steel plate
- ▶ 5114-050 or 5114-051 weigh 0.92 lb (0.42 kg)



5114-01 — Quick-Release Triple Mag Mount 
5114-02 — 5/8 x 11 Triple Mag Mount 
5114-10 — Triple Mag Mount for Trimble R10 
5114-050 — 5/8 x 11 Tip 
5114-051 — Quick-Release Tip 

- ▶ The Satellite Stick™ XL is composed of six, 1-in (25.4-mm) OD carbon fiber sections
- ▶ Collapses to 1.23-ft (37.5-cm)
- ▶ Includes carrying bag
- ▶ Weighs 2.40 lb (1.09 kg)



5126-10 — Satellite Stick XL 

- ▶ SECO's Tripod Radio Antenna Kit attaches easily to instrument tripods
- ▶ Tripod leg clamp will attach to any tripod leg and ram ball and socket section of clamp quickly. Sets the antenna pole up vertically
- ▶ A large washer is included to allow a straight connection to a tripod for a separate setup
- ▶ Kit consists of three antenna sections that set up the radio antenna pole height to 3.1 ft (0.95 m) above the tripod
- ▶ Kit bag measures 16 x 6 x 2-inches (40.6 x 15.2 x 5.8-cm)
- ▶ Weighs 1.90 lb (0.86 kg)



5133-06 — Tripod Radio Antenna Kit 

- ▶ GNSS Compass for 1.25 inch (3.18 cm) diameter poles



5125-050 — GNSS Compass 

- ▶ Constructed from anodized aluminum



5120-00 — Tripod Adapter 3-1/2 x 8 to 5/8 x 11 
5130-00 — Tripod Adapter 5/8 x 11 to 3-1/2 x 8 
5132-01 — Tripod Adapter 5/8 x 11F to 1/4 x 20M 

Drone Ground Control Targets



FEATURES & BENEFITS

- ▶ Drone, GCP, Ground Control Points set
- ▶ Target size 18X18X1/8"
- ▶ Compatible with any drone software that recognizes GCP targets

- ▶ Numbered 1-10
- ▶ Orange/Black color
- ▶ Made from rigid weather resistant ACM Panel. (Aluminum Composite Material)
- ▶ Center hole, 1/4", to center over existing control point

- ▶ Carrying bag made of tough Rhinotech and Polyester materials, #10 YKK zipper
- ▶ Weight ea. 1.65 lbs.
- ▶ Weight in the included carrying bag 18.5 lbs.

Minimum Order Quantity 3.
This product does not qualify for Free Freight.



6705-30 — Drone Ground Control Targets



Propeller AeroPoints Generation 2



FEATURES & BENEFITS

- ▶ Generation 2 Propeller AeroPoints offers significant upgrades.
- ▶ More Capability Without Complexity.
- ▶ A new wifi chip adds fast and

- reliable connectivity.
- ▶ Dual-frequency delivers shorter flight times and more robust positioning.
- ▶ An upgrade to battery performance and plug-in charging gives customers better

- battery life and flexibility out in the field.
- ▶ And there's a brand new AeroPoints app that doubles down on diagnostic issues and makes configuration setup a breeze.

Minimum Order Quantity 10.

One-button operation

Just place and press. Indicator light displays current status.

Solar powered

Low maintenance. Charges while running. Powerful LiFePO₄ battery for long storage life.

Rugged and durable

Water-resistant. Aerodynamic shape prevents shifting and aids water runoff.

Charging port

Charge up your AeroPoints in just three hours using the charging port.



In-built GPS

Records positioning data every 5 seconds.

Lightweight

1.5kg (3.3lb). Each set includes a carry bag for easy transport.

Large memory

Store data from 100-plus flights before upload is required.

Strategic design

Optimized for recognition by processing software.

AP-10PK — Propeller AeroPoints Generation 2



GNSS Bracket for Truck Door

Expands vertically from 47 to 61 inches



FEATURES & BENEFITS

- ▶ This bracket holds a GNSS pole to the door of your survey truck
- ▶ Easy to put on and take off and features a non-damaging mount
- ▶ 5114-20 fits most trucks and SUVs
- ▶ The door opens and closes with the bracket attached to the door
- ▶ Bracket holds all GNSS- and RTK type poles
- ▶ Utilizes a safety strap under tension to keep it on the door

- ▶ Brackets are available to hold controller inside the cab
- ▶ Designed for off-road use
- ▶ Both products available in colors FLY, FOR, YEL
- ▶ Weighs 6.20 lb (2.80 kg)

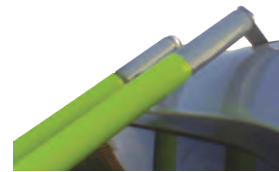
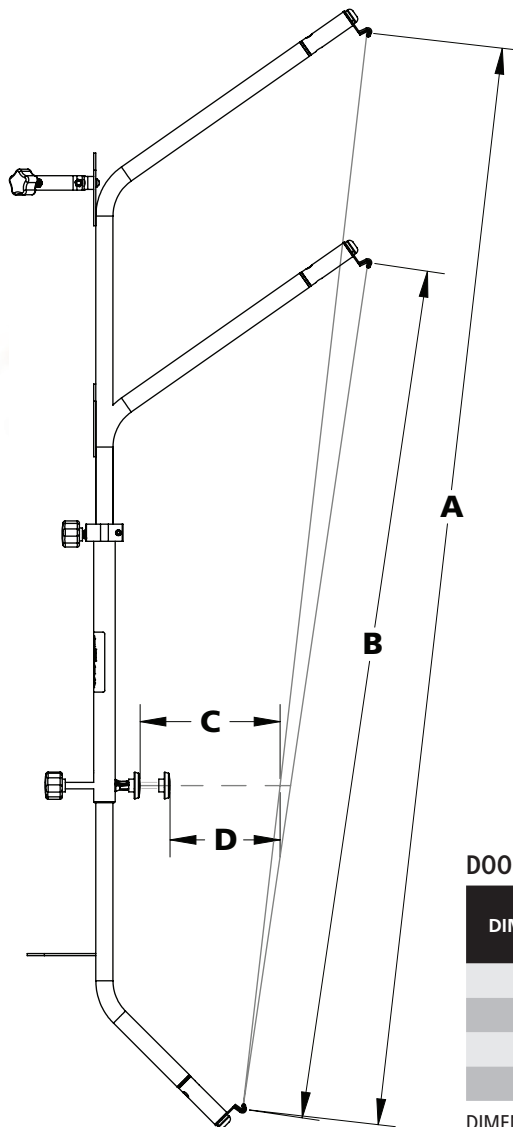

5114-20-051
3-inch Extension Kit for Dodge and other truck models

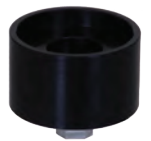

5114-20-050
Topo Shoe Adapter

DOOR FIT DIMENSIONS

DIMENSION	5114-20-XXX	5114-20-XXX W/ 5114-20-051 EXTENSION KIT	5114-21-XXX
A	4'-11" (59")	5'-3" (63")	4'-11" (59")
B	3'-10" (46")	4'-2" (50")	3'-10" (46")
C	6-3/8"	8-3/4"	7"
D	4-1/2"	6-1/2"	5"

DIMENSION TOLERANCE +/- 1/4"

5114-20-XXX — GNSS Bracket for Truck
5114-21-XXX — Ford F-150 2015 & 2016 models



UTV Roll Cage Transporter for GNSS Rods

Easy set-up or disassembly in 10 minutes or less



FEATURES & BENEFITS

- ▶ The RUXWORKS GNSS Rod Transporter™ fits all popular UTVs
- ▶ Mounts easily to either side and installs in 10 minutes or less

- ▶ The UTV bracket has up to 30° of tilt to set your rover rod plumb
- ▶ The pole clamp section is 63-in (160-cm) long and disassembles quickly from the UTV bracket with two quick release pins or two bolts

- ▶ The UTV bracket can stay permanently attached to the UTV
- ▶ Includes a rod clamp that fits all popular rover rods and poles with points and/or topo shoes up to a 2-1/2-inch (6.35-cm) diameter

PART NO.	FITS	WEIGHS	
5114-40-01	Tubular Roll Cage up to 2-inches (5.08 cm)	15.00 lb (6.80 kg)	
5114-40-02	Rectangular Roll Cage up to 2 x 4-inch (5.8 x 10-cm)	15.00 lb (6.80 kg)	

ATV Bracket for TSC7 / Ranger 7



FEATURES & BENEFITS

- ▶ Works with ATVs, Snowmobiles, and Motorcycles
- ▶ Fits handlebars from 0.5 to 1.25 inches in diameter
- ▶ Also fits TSC3 / Ranger3

- ▶ Two links included for different height location. Long Link 5.625", Short Link 3.5"
- ▶ Uses 1.5" balls for stable positioning holding
- ▶ Weighs only 1.4lbs 0.64kg



5198-52 – Bracket ATV, TSC7 / Ranger 7

Plan Holder

Conveniently organize and store job site materials in your vehicle



FEATURES & BENEFITS

- ▶ Plan holder hangs on the back or front of any vehicle seat
- ▶ Slots which hold four 6-inch (15.24 cm) diameter plans

- ▶ Front pocket accommodates a note pad, phone, or other small items
- ▶ Organizer strap holds pens, pencils, markers, and other necessary tools

- ▶ Weighs 0.95 lb (0.43 kg)

8046-10-BLU — Plan Holder

Vials

Vial for TLV™ Locks



 **5500-064-40 - Vial Assembly (Complete with 40-min vial)**

-  40-Minute Vial D11232 Includes screws 
-  20-Minute Vial D11233 Includes screws 
-  8-Minute Vial D11234 Includes screws 

Vial for QLV™ Locks



 **5801-052-40 - Vial Assembly (Complete with 40-min vial)**

-  40-Minute Vial D11243 Includes screws 
-  20-Minute Vial D11242 Includes screws 
-  8-Minute Vial D11241 Includes screws 

Vial for 1.25-inch OD Pole Levels



 **5081-052-40 - Vial Assembly (Complete with 40-min vial)**

-  40-Minute Vial D11232 Includes screws 
-  20-Minute Vial D11233 Includes screws 
-  8-Minute Vial D11234 Includes screws 

Vial for 1.50-inch OD Pole Levels



 **5070-051-40 - Vial Assembly (Complete with 40-min vial)**

-  40-Minute Vial D11232 Includes screws 
-  20-Minute Vial D11233 Includes screws 
-  8-Minute Vial D11234 Includes screws 

Levels

- ▶ No longer need to look down while traffic is flying by — simply look through the window
- ▶ Features a soft rubber knob on an adjustable clamp that fit most survey poles and most vials
- ▶ The Heads-Up™ level is more comfortable to read; the bubble is direct reading
- ▶ Fits 1- to- 1.25-inch (25.4- to- 31.75-mm) OD poles
- ▶ Weighs 0.40 lb (0.18 kg)



5001-20 — Heads-Up™ Level - 40-minute Vial 

- ▶ Features a die-cast aluminum body and adjustable vial
- ▶ Use with track light, robotic instruments, or conventional leveling
- ▶ Fits round or rectangular rods
- ▶ Feature a 40-minute sensitivity
- ▶ Weighs 0.50 lb (0.22 kg)



5001-10 — Standard Rod Level 

- ▶ Features a die-cast aluminum body and adjustable vial
- ▶ Suitable for use with track light, robotic instruments, or conventional leveling
- ▶ Fits round or rectangular rods
- ▶ Fits poles with a 1- to- 1.25-inch (25.4- to- 31.75-mm) OD
- ▶ Feature a 40 minute sensitivity vial
- ▶ Weighs 0.10 lb (0.04 kg)



5001-12 — Snap-On Rod Level 

Scanner Spheres



FEATURES & BENEFITS

- ▶ 100 mm OD lightweight aluminum sphere
- ▶ Precision design, allowable deviation < 1 mm

- ▶ Female 1/4 x 20 threaded mounting
- ▶ Painted non-glare white
- ▶ Weighs 0.60 lb (0.27 kg)

- ▶ Center height is 49 mm from bottom flat
- ▶ Height adapters: 6703-005 or 6703-002 see page 20

6703-001 — 100 mm Scanner Sphere

FEATURES & BENEFITS

- ▶ Lightweight aluminum scanner sphere
- ▶ 230 mm diameter, accuracy < 2 mm

- ▶ Female 5/8 x 11 threaded mounting
- ▶ Painted non-glare white
- ▶ Center height is 114 mm from bottom flat

- ▶ Weighs 2.70 lb (1.22 kg)
- ▶ Sphere comes in a drawing carrying pouch. For an additional bag, order PN D12560 (for 230 mm)

6704-001 — 230 mm Scanner Sphere

Sphere Adapters, Accessories and Case

- ▶ 3-7/8 inch diameter housing
- ▶ 3-1/2 inch ceramic grade 5 magnet
- ▶ 120 pounds of pull force
- ▶ Stainless steel 5/8 x 11 stud
- ▶ Height is 21 mm
- ▶ Weighs 0.95 lb (0.43 kg)



6704-002 — Magnet with 5/8 x 11 Stud

- ▶ Anodized aluminum body
- ▶ Male and female 5/8 x 11 threads
- ▶ Height is 21 mm
- ▶ Center height is 135 mm with 230 mm Sphere (6704-001)
- ▶ Weighs 0.05 lb (0.02 kg)



6704-003 — 21 mm Male and Female 5/8 x 11 Adapter

- ▶ Anodized aluminum body
- ▶ Male and female 5/8 x 11 threads
- ▶ Height is 48 mm
- ▶ Center height is 196 mm with 230 mm Sphere (6704-001) and Tribrach Adapter (2070-00)
- ▶ Weighs 0.10 lb (0.04 kg)



6704-004 — 48 mm Male and Female 5/8 x 11 Adapter

- ▶ Includes three 230 mm scanner spheres in a hard case
- ▶ Includes cover bag for each sphere for insulation and scratch protection
- ▶ Airline approved shipping case
- ▶ Weighs 17.60 lb (7.98 kg)



6704-10-CASE — Carrying Case solo
 D12560 — Cloth cover for the 230 mm sphere
 6704-10 — Hard Case and three (3) 230 mm Scanner Spheres

- ▶ 3/8 x 16 stainless steel male stud
- ▶ Three prong tribrach interface connection
- ▶ Height is 60.5 mm
- ▶ Height to target with the TX5 / FARO3D achieves 196 mm
- ▶ Weighs 1.35 lb (0.61 kg)



6703-011 — 196 mm HT Tribrach Adapter for TX5/FARO3D

- ▶ "Quick Release Adapter" specifically for Trimble TX5 and Faro Focus 3D scanners
- ▶ Quick and safe connection between the scanner instrument and a Gitzo or any tripod with a male 3/8 x 16 thread
- ▶ Rotates smoothly on Delrin® bearing for orientating the instrument

- ▶ Clamp screw is captured and protected from damage
- ▶ Anodized aluminum and stainless steel materials
- ▶ Base has a setscrew to lock base to tripod head
- ▶ Built-in 100-minute level vial on base
- ▶ Weighs 0.70 lb (0.32 kg)



6703-015 — Quick Release Adapter for Trimble TX5 and Faro Focus 3D

100 mm Sphere Prisms, Adapters, Magnets and Kits

- ▶ Lightweight aluminum sphere and ceramic grade 8 magnet
- ▶ Steel cup OD 2.03 inches
- ▶ Stainless steel 1/4 x 20 stud
- ▶ Center height: 72.5 mm
- ▶ Magnet is chrome coated

- ▶ steel cup and offers 40 pull pounds
- ▶ 100 mm OD roundness <1 mm
- ▶ 1/4 x 20 threaded mounting
- ▶ Painted non-glare white
- ▶ Weighs 0.80 lb (0.36 kg)



6703-10 — 100 mm Scanner Sphere with Magnet 

- ▶ 1/4 x 20 stainless steel male stud
- ▶ 5/8 x 11 female connection
- ▶ Height is 23.5 mm
- ▶ Height to target with 100 mm sphere achieves 72.5 mm
- ▶ Weighs 0.05 lb (0.02 kg)



6703-005 — 5/8 x 11, 72.5 mm HT Adapter 

- ▶ 25 mm silver-coated prism
- ▶ -17.5 mm offset
- ▶ Length is 72.5 mm prism center to connections
- ▶ 5/8 x 11 female and magnetic connection
- ▶ Weighs 0.75 lb (0.34 kg)



6703-012 — 72.5 HT Prism Assembly with Magnet 

- ▶ Rubber tips on stainless-steel legs prevent scratching of delicate surfaces
- ▶ Folding legs make tripod very portable
- ▶ Made of anti-corrosive materials
- ▶ Steel-plated washer atop tripod easily attaches to scanner sphere
- ▶ Height is 39 mm
- ▶ Weighs 0.15 lb (0.07 kg)
- ▶ (Sphere not included)



6703-008 — Scanner Sphere Mini Tripod 

- ▶ 6703-20 includes six 100 mm scanner spheres and six magnets with 1/4 x 20 studs
- ▶ Sphere center height with magnet: 72.5 mm
- ▶ Weighs 6.60 lb (3.00 kg)



6703-20 — 6 piece 100 mm Sphere Kit includes Soft Case 

- ▶ Compatible with the TX5
- ▶ Width is 3.12 in (79.3 mm)
- ▶ Height is 34 mm
- ▶ Weighs 1.75 lb (0.80 kg)



2070-02 — 3/8 x 16 Tribrach Adapter 

- ▶ Zinc-plated steel material
- ▶ 1.90 in (48.26 mm) in diameter
- ▶ Thickness is 0.098 in (2.5 mm)
- ▶ 0.24 in (6 mm) countersink hole connection
- ▶ Weighs 0.05 lb (0.02 kg)



6703-007 — Wall Washer Adapter 

- ▶ Brass washers centers to 6703-002 magnet base connection
- ▶ 90 pounds of pull force
- ▶ Connects to pipes and flat surfaces
- ▶ Weighs 0.90 lb (0.41 kg)

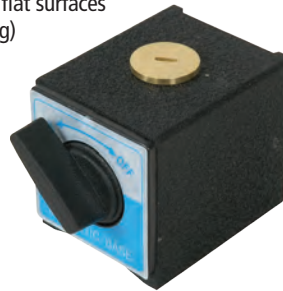

6703-013 — V-Base with Washer Magnet 

- ▶ Six padded compartments (for 100 mm spheres, sold separately)
- ▶ Made from 1000D Cordura with 2 inch padded foam and includes a carrying handle
- ▶ Stowable straps (cases can connect together)
- ▶ Outside Dimensions: 16 x 11 x 8 in (40.64 x 27.94 x 20.32 cm)
- ▶ Inside Dimensions: 13 x 9.5 x 4 in (33.02 x 24.13.94 x 10.16 cm)
- ▶ Weighs 2.00 lb (0.91 kg)



8082-01-ORG — Soft Case for 100 mm Scanner Spheres 

- ▶ Stainless steel 1/4 x 20 stud
- ▶ Chrome-plated steel cup
- ▶ 2.03 inch OD steel cup
- ▶ Grade 8 ceramic magnet
- ▶ Center height when using the 6703-001 is 72.5mm
- ▶ 40 pounds (18.14 kg) of pull force
- ▶ Weighs 0.20 lb (0.09 kg)



6703-002 — Magnet with 1/4 x 20 Stud 

- ▶ Pelican® hard shell case features custom foam keeping spheres, prisms, adapters, etc., safe and secure
- ▶ 6703-11 includes ten 100 mm scanner spheres and ten magnets with 1/4 x 20 studs
- ▶ Dimensions: 24.5 x 19 x 9 in (62.3 x 48.3 x 22.9 cm)
- ▶ Weighs 22.00 lb (10.00 kg)



6703-11 — 10 piece 100 mm Sphere Kit includes Hard Case 

- ▶ Pelican® hard shell case features custom foam keeping spheres, prisms, adapters, etc., safe and secure
- ▶ Same dimensions as 6703-11
- ▶ Weighs 14.00 lb (6.36 kg)



6703-014 — Pelican Case for 100 mm Spheres (spheres sold separately) 

Scanner Targets



FEATURES & BENEFITS

- ▶ Adjustable tilting target, for affixing to pole top and used in multiple survey jobs.

- ▶ Contrasting 6" (152mm) Black and White pattern
- ▶ Matte non-glare target material
- ▶ Adjustable tilting axis

- ▶ Anodized aluminum yoke and target plate
- ▶ Axis height 135mm
- ▶ 5/8-11 threaded base
- ▶ Weight 0.90 lbs, 0.41kg

6705-10 — Target, Tilting, 6" B/W



FEATURES & BENEFITS

- ▶ Easy-to-use self-adhesive target, which can be fixed to measuring points.
- ▶ Ideal for monitoring work where you have to leave targets in position over long periods.

- ▶ Contrasting 6" (152mm) Black and White pattern
- ▶ Matte non-glare target material
- ▶ Material is 3M 3.2-mil vinyl films with a pressure-sensitive adhesive and air release channels for easier, bubble-free application. Easy to remove,

- ▶ leaves no adhesive.
- ▶ Weather resistant and UV stable.
- ▶ Space to mark target ID
- ▶ Adhesive backed
- ▶ Package weight: 0.25 lbs (0.11 kg)

6705-20 — Target, Adhesive, 150X200mm, B/W, 10pk

Carbon Fiber Robotics Poles

Features carbon fiber and TLV locking mechanism



FEATURES & BENEFITS

- ▶ Graduated to read direct for a 135 mm prism height
- ▶ Adapters will achieve other prism heights
- ▶ Carbon fiber pole offers a

- ▶ stainless steel pin which locks the inner pole
- ▶ Features TLV™ lock mechanism with 40-minute vial built-in
- ▶ Optional outer graduations in metric (GM) or 10ths/100ths (GT)

- ▶ Swiss Style Pole (SW) includes the 2090-10 adapter fixed to the pole
- ▶ Order 8160-00-ORG for carrying case

PART NO.	GRADS	SECTIONS	PIN LOCKING	OUTER GRADS	LENGTH	WEIGHS	
5129-52	Dual	1	Every 0.5 ft	10ths/100ths (GT)	4.97 ft - 8.53 ft	2.30 lb (1.04 kg)	
5129-53	Metric	1	Every 20 cm	Metric (GM)	1.53 m - 2.6 m	2.30 lb (1.04 kg)	
5129-72	Dual	2	Every 0.5 ft	None	5.18 ft - 11.81 ft	3.30 lb (1.50 kg)	
5129-73	Metric	2	Every 20 cm	None	1.58 m - 3.6 m	3.30 lb (1.50 kg)	
5129-52-SW	Dual	1	Every 0.5 ft	10ths/100ths (GT)	8.5 ft / 2.6 m	2.3/1.04 kg	
5129-53-SW	Metric	1	Every 20 cm	Metric (GM)	8.5 ft / 2.6 m	1.04 kg	
5129-72-SW	Dual	2	Every 0.5 ft	10ths/100ths (GT)	11.8 ft / 3.6 m	3.3/1.5 kg	
5129-73-SW	Metric	2	Every 20 cm	Metric (GM)	11.8 ft / 3.6 m	1.5 kg	

Telescopic Carbon Fiber Prism Pole

Carbon fiber poles are approximately 30% lighter than similar aluminum poles



FEATURES & BENEFITS

- ▶ Adjustable tip that will adjust to a prism height of 65 mm to 115 mm

- ▶ TLV locking and dual graduations and OD is 1.27 in (32 mm)
- ▶ Extends 8.53 ft (2.60 m)

- ▶ Collapses to 4.97 ft (1.51 m)
- ▶ Weighs 2.30 lb (1.05 kg)

5129-54 — Adjustable Tip Carbon Fiber Pole

Mini Poles

Compact, easy to set up, and convenient to store and transport



FEATURES & BENEFITS

- ▶ Mini poles are easy to use
- ▶ Adjustable or fixed-tip poles
- ▶ Light weight and convenient to transport and store
- ▶ 40-minute bubble vials
- ▶ Powder-coated and silk screened aluminum

PART NO.	HEIGHT	GRADS	LOCK TYPE	PRISM HEIGHT	WEIGHS	
5500-23	2.70 ft - 5.10 ft (0.82 - 1.55 m)	Dual	TLV	50 mm - 115 mm	2.30 lb (1.04 kg)	
5010-00-RED	1.28 ft (0.39 m)	N/A	N/A	N/A	1.50 lb (0.68 kg)	
5010-00-FLY	1.28 ft (0.39 m)	N/A	N/A	N/A	1.50 lb (0.68 kg)	
5010-01	4.7 inches (120 mm)	N/A	N/A	25 mm	0.40 lb (0.02 kg)	
5700-21	2.26 ft - 4.8 ft (0.7 - 1.5 m)	Dual	Quick-Release	50 mm - 115 mm	2.33 lb (1.80 kg)	

Swiss-Style QLV Prism Poles

QLV Locking Mechanisms



FEATURES & BENEFITS

- ▶ Swiss-style quick release stud Reads direct for any 86 mm height prisms
- ▶ The small-diameter, 25 mm bottom section fits Leica slide-on controller brackets
- ▶ QLV™ locking mechanisms
- ▶ Powder-coated and silk screened aluminum
- ▶ Lower lock features a 40-minute vial

Part No.	LENGTH	TIP	Type	GRADS	WEIGHS	
5802-10	8 ft	Swiss-Style	Aluminum	Dual	2.50 lb (1.13 kg)	
5802-20	12 ft	Swiss-Style	Aluminum	Dual	3.55 lb (1.61 kg)	

Swiss-Style TLV and Twist-Lock Prism Poles

Twist Lock with Vial (TLV)



FEATURES & BENEFITS

- ▶ Swiss-style tip (for 86 mm prism heights) for GPH1-type prisms
- ▶ 1.25- or 1.50-inch (31.75- or 38.1-mm) outside diameter
- ▶ Dual or metric graduations TLV™ or Twist-Lock mechanisms
- ▶ Comes in 1 or 3 sections
- ▶ The popular TLV locking system provides simple but secure locking

PART NO.	SECTIONS	LOCK STYLE	LENGTH	OD	GRADS	WEIGHS	
5501-11	1	TLV	8.53 ft - 4.97 ft (2.60 m - 1.51 m)	1.25 inch (31.75 mm)	Dual	3.30 lb (1.50 kg)	
5521-11	1	TLV	2.60 m - 1.51 m	31.75 mm	Metric	3.30 lb (1.50 kg)	
5503-30	3	Twist-Lock	15.25 ft - 5.41 ft (4.65 m - 1.65 m)	1.50 inch (38.1 mm)	Dual	7.60 lb (3.45 kg)	

Quick-Release Telescopic Prism Poles

Vials are on the locks, out of the way of the instruments on the pole



FEATURES & BENEFITS

- ▶ Quick-Release locking mechanism with 40-minute vial
- ▶ Adjustable tension via set

- screw in the handle and another set screw to assist in keeping the spring in position
- ▶ Quick-Release handle lock

- allows for a simple and fast setup
- ▶ Constructed of powder-coated and silk screened aluminum

PART NO.	GRADS	SECTIONS	TIP	EXTENDED	COLLAPSED	WEIGHS	
5700-10	Dual	1	Adjustable	8.53 ft (2.60 m)	4.97 ft (1.52 m)	3.30 lb (1.50 kg)	
5720-10	Metric	1	Adjustable	8.53 ft (2.60 m)	4.97 ft (1.52 m)	3.30 lb (1.50 kg)	
5700-20	Dual	2	Adjustable	11.81 ft (3.60 m)	5.18 ft (1.58 m)	5.10 lb (2.30 kg)	

TLV and Twist-Locking Telescopic Prism Poles

The popular TLV™ locking system provides simple but secure locking



FEATURES & BENEFITS

- ▶ The aluminum twisting lock with vial (TLV) pole is wear-resistant for long life

- ▶ The soft rubber knob is easy to tighten or loosen, even when wearing gloves
- ▶ TLV locks feature a convenient 40-minute vial built into the lock

- ▶ Made of quality aluminum tubing
- ▶ Powder-coated red and white
- ▶ Vials may be switched out – see page 18 for options

Part No.	SECTIONS	TIP	EXTENDED	COLLAPSED	GRADS	WEIGHS	
5500-11	1	Adjustable	8.53 ft (2.60 m)	4.97 ft (1.52 m)	Dual	3.30 lb (1.50 kg)	
5512-11	1	Fixed	8.53 ft (2.60 m)	4.97 ft (1.52 m)	Dual	3.30 lb (1.50 kg)	
5520-11	1	Adjustable	8.53 ft (2.60 m)	4.97 ft (1.52 m)	Metric	3.30 lb (1.50 kg)	
5500-21	2	Adjustable	11.81 ft (3.60 m)	5.18 ft (1.58 m)	Dual	5.10 lb (2.32 kg)	
5520-21	2	Adjustable	11.81 ft (3.60 m)	5.18 ft (1.58 m)	Metric	5.10 lb (2.32 kg)	
5500-30	3	Adjustable	15.25 ft (4.65 m)	5.41 ft (1.65 m)	Dual	7.60 lb (3.45 kg)	
5520-30	3	Adjustable	15.25 ft (4.65 m)	5.41 ft (1.65 m)	Metric	7.60 lb (3.45 kg)	

Quick Change Pole Adapters

Use with SECO Quick Change Prism Poles to achieve desired height

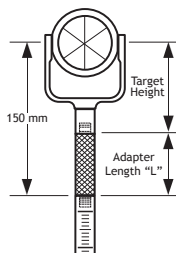

FEATURES & BENEFITS

- ▶ Using adapters, any of the poles in the Quick Change series can be used for GNSS,

- robotics or total station surveys
- ▶ Quick conversions to another application by changing adapters

- ▶ Simple adapter determinations: 150 mm minus your target height = length of adapter needed

Part No.	Target	Target Height	Length "L"	
2090-10	Leica GPH1	60 mm	90 mm	
2090-11	SECO 6400 Series	100 mm	50 mm	
2090-12	SECO 6400 Series	115 mm	35 mm	
2090-13	Trimble RMT	135 mm	15 mm	
2090-14	Adjustable 5/8 x 11	50 mm to 135 mm	N/A	
2090-15	GNSS Antenna	0 mm	150 mm	
2090-17	Leica Adjustable	86 mm to 125 mm	N/A	
2090-19	SECO Mini Prisms	70 mm	80 mm	
2090-21	Topcon 360 Prism	77 mm	73 mm	
2090-26	Topcon APT1/2	50 mm	100 mm	
5079-066	Laser Detector Adapter	0 mm	150 mm	

Compression Lock Telescopic Prism Poles

Constructed of brass and aluminum



FEATURES & BENEFITS

- ▶ Compression locking mechanism
- ▶ Constructed of sturdy aluminum tubing and a two-stage adjustable top-threaded tip
- ▶ Adjustable Tip
- ▶ Single (1) section pole
- ▶ Extends 8.53 ft (2.60 m)
- ▶ Collapses 4.97 ft (1.516 m)
- ▶ Dual graduations
- ▶ Finished with electrostatic powder paint coating on the outer pole and permanent silkscreened grads on the inner pole
- ▶ Weighs 3.30 lb (1.50 kg)

5600-10 — Compression Prism Pole

QLV Locking Prism Poles

Simple to adjust bubble and lever tension

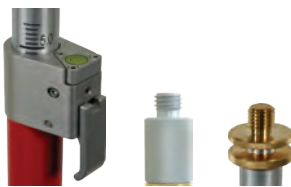

QLV lock body Fixed Tip Adjustable Tip

FEATURES & BENEFITS

- ▶ The QLV™ (Quick Lever with Vial) lock allows fast, simple setups
- ▶ Simple to adjust bubble and lever tension
- ▶ Includes a lock with 40-minute level vial, adjustable, or fixed tip and your choice of dual (10ths) or metric graduations (cm)
- ▶ Easy locking
- ▶ Finished with electrostatic powder paint coating on the outer pole and permanent silkscreened grads on the inner pole

PART NO.	SECTIONS	TIP	Extends	Collapses	GRADS	WEIGHS	
5801-10	1	Adjustable	8.53 ft (2.60 m)	4.97 ft (1.516 m)	Dual	2.95 lb (1.50 kg)	
5813-10	1	Fixed	8.53 ft (2.60 m)	4.97 ft (1.516 m)	Dual	2.95 lb (1.50 kg)	

Ultralite Prism Poles

Non-conductive fiberglass



FEATURES & BENEFITS

- ▶ The lightest pole offered by SECO
- ▶ Included in this package is Seco's patented Topo Boot®
- ▶ Reduced weight SECO TLV™ lock
- ▶ Features a 40-minute adjustable vial, a soft touch knob, and an adjustable 5/8 x 11 tip
- ▶ The inner and outer poles are constructed of lightweight non-conductive fiberglass
- ▶ Vials may be switched out – see page 18 for options

PART NO.	SECTIONS	TIP	LENGTH	VIAL	GRADS	WEIGHS	
5540-10	1	Adjustable	8.58 ft (2.62 m)	40-minute	Dual	1.95 lb (0.88 kg)	
5541-10	1	Adjustable	2.62 m (8.58 ft)	40-minute	Metric	1.95 lb (0.88 kg)	
5540-20	2	Adjustable	11.81 ft (3.60 m)	40-minute	Dual	2.50 lb (1.13 kg)	
5541-20	2	Adjustable	3.60 m (11.81 ft)	40-minute	Metric	2.50 lb (1.13 kg)	
5540-30	3	Adjustable	15.27 ft (4.65 m)	40-minute	Dual	3.15 lb (1.43 kg)	
5541-30	3	Adjustable	4.65 m (15.27 ft)	40-minute	Metric	3.15 lb (1.43 kg)	

**Contractor Series
TLV Prism Poles**

Import TLV™ prism poles



FEATURES & BENEFITS

- ▶ Dual-section Twist lock Prism Pole
- ▶ Aluminum outer and inner pole
- ▶ Includes 40-minute level vial
- ▶ 5/8 Adjustable Tip
- ▶ Metric Grad (cm)
- ▶ Hardened steel points
- ▶ TLV locking mechanism
- ▶ Color: Red and White
- ▶ Length 3.60 m (11.81 ft),
- ▶ Weighs 3.65 lb (1.66 kg)

PART NO.	SECTIONS	TIP	LENGTH	POLE TYPE	GRADS	WEIGHS
5530-10	1	Adjustable	8.53 ft (2.60 m)	Aluminum	Dual	2.67 lb (1.21 kg)
5531-10	1	Adjustable	2.60 m	Aluminum	Metric	2.67 lb (1.21 kg)
5530-20	2	Adjustable	11.81 ft (3.60 m)	Aluminum	Dual	3.65 lb (1.66 kg)
5531-20	2	Adjustable	3.60 m	Aluminum	Metric	3.65 lb (1.66 kg)
5530-30	3	Adjustable	15.25 ft (4.65 m)	Aluminum	Dual	5.38 lb (2.44 kg)
5531-30	3	Adjustable	4.65 m	Aluminum	Metric	5.38 lb (2.44 kg)

**Contractor Series
Compression Lock Poles**

Traditional Compression lock import prism poles



FEATURES & BENEFITS

- ▶ These 'no-frills' imported poles are designed to give service in the field at a lower purchase price
- ▶ Your choice of metric (cm) or dual (cm/10ths) graduations
- ▶ Aluminum outer and inner pole
- ▶ 40-minute level vials
- ▶ Adjustable tip
- ▶ Hardened steel points
- ▶ Red and white color

PART NO.	SECTIONS	TIP	LENGTH	POLE TYPE	GRADS	WEIGHS
5631-10	1	Adjustable	2.60 m (8.53 ft)	Aluminum	Metric	2.65 lb (1.20 kg)
5631-20	2	Adjustable	3.60 m (11.81 ft)	Aluminum	Metric	3.45 lb (1.56 kg)
5631-30	3	Adjustable	4.65 m (15.25 ft)	Aluminum	Metric	5.00 lb (2.27 kg)

Offset Tools

- ▶ Used with total stations and prism poles to help get accurate elevation measurements in hard-to-reach places such as sewer lines
- ▶ Has an adjustable centerline, 1.60 to 1.00-ft (48.76 to 30.48-cm) in 0.20-ft (6.09-cm) increments
- ▶ Constructed of anodized 1/2 inch thick aluminum
- ▶ Includes brass male 5/8 x 11 threaded post and a stainless steel 5/8 x 11 Heli-Coil®
- ▶ Weighs 1.15 lb (0.52 kg)
- ▶ Maintains Exact Pole Elevation Readings!



5198-163 — Adjustable Offset Bar

- ▶ Perform odd setups and stay away from dangerous situations with the Offset Pole Holder Kit
- ▶ Combine the kit with any 5/8 x 11 threaded pole and a Heads-Up™ Level (PN 5001-20, page 18) for a safe and sturdy setup
- ▶ A padded case, hex wrench, and an adapter plate for instrument tripods is included
- ▶ Weighs 1.79 lb (0.81 kg)



5198-157 — Offset Pole Holder Kit

Prism Tips and Topo Shoes

- ▶ 3.37-inch (85.6-mm) steel body
- ▶ Weighs 0.30 lb (0.14 kg)



5190-00-KIT — 15 each, 
Prism Pole Point

- ▶ 3.37-inch (85.6-mm) steel body, removable point
- ▶ Weighs 0.30 lb (0.14 kg)



5194-00 — Prism Pole Point 
with Replaceable Plumb Bob Point

- ▶ 3.37-inch (85.6-mm) aluminum body
- ▶ Removable point
- ▶ Weighs 0.10 lb (0.05 kg)



5194-01 — Aluminum 
Replaceable Point

- ▶ 3.37-inch (85.6-mm) aluminum with steel tip (91605)
- ▶ Weighs 0.01 lb (0.004 kg)
- ▶ The topo-shoe (91601) screws over the precision point made of black nylon and increases the area of the point for the use on soft surfaces in topo shots
- ▶ Weighs 0.05 lb (0.02 kg)



91605 — Aluminum Prism Pole 
Point and Steel Tip
91601 — Topo Shoe 

- ▶ Features an 'L-Bracket' to rest the prism pole point on and the adjustable top piece
- ▶ Convenient for adjusting and calibrating pole vials in the office
- ▶ Use the adjustable top to center your pole before adjusting the bubble
- ▶ Weighs 1.00 lb (0.45 kg)



5195-01 — Pole Peg Adjusting Jig 

- ▶ 3.37-inch (85.6-mm) anodized aluminum body, steel point
- ▶ Weighs 0.16 lb (0.07 kg)



5194-03-KIT — 15 each, 
15 each, Prism Pole Point, Dull

- ▶ 3.37-inch (85.6-mm) anodized aluminum body, dull point
- ▶ Weighs 0.16 lb (0.07 kg)



5194-007-KIT — 40 each, 
Prism Pole Dull Point

- ▶ Hardened steel replacement point for 5194-series
- ▶ Weighs 0.06 lb (0.03 kg)



5194-003-KIT — 40 each, 
Prism Pole Sharp Point

- ▶ This point features an anodized aluminum body and an easy-to-replace steel point
- ▶ Weighs 0.16 lb (0.07 kg)



5194-05-KIT — 15 each, Prism 
Pole Point, Sharp

- ▶ This prism allows for easy determination of right angle points or perpendicular points between two targets



4900-00 — Double Right-Angle 
Prism

- ▶ Stedi-Rest® fits any 1.25 to 1.5 inch (31.75 to 38.1-mm) pole and can take the place of three separate products
- ▶ Weighs 0.15 lb (0.07 kg)



91641 — Stedi-Rest® 

- ▶ The Center Punch Point fits all poles or products with male 5/8 x 11 threads
- ▶ The hardened steel point will mark all metal and non-metal surfaces
- ▶ Weighs 0.20 lb (0.09 kg)



5194-10 — Center Punch Point 
5194-10-002 — Replacement Point

- ▶ The point features an aluminum body and an easy-to-replace steel point
- ▶ Male 5/8 x 11 Thread
- ▶ Weighs 0.16 lb (0.07 kg)



5194-04 — Point Assembly 

- ▶ 3.37-inch (85.6-mm) aluminum body
- ▶ Weighs 0.34 lb (0.15 kg)



5191-00 — Prism Pole Topo Shoe 

- ▶ 3.37-inch (85.6-mm) length
- ▶ 64 mm OD with steel body
- ▶ Weighs 1.26 lb (0.57 kg)



5192-00 — Wide Base Topo Shoe 

- ▶ Allows easy conversions from 'control' to 'topo' surveys



5192-02 — Topo Shoe 
and Point Combo

- ▶ 2-inch (50.8-mm) diameter chrome-plated steel housing ring with grade-8 ceramic magnet ring
- ▶ Standard topo shoe length, 3.375-inch (85.7-mm)
- ▶ Magnet has 40 pounds of pull force on 3/8-inch (9.5-mm) clean steel plate
- ▶ Female 5/8 x 11 threads are machined brass
- ▶ Black anodized aluminum alloy 6061 body
- ▶ Tilting pivot allows measurement on sloped or flat pipe surfaces
- ▶ Weighs 0.55 lb (0.25 kg)



5193-04 — Tilting Magnetic Topo Shoe 

Range Pole Accessories



- ▶ The Rodrest is a self-retracting 'kickstand' for survey rods
- ▶ Activated by simply pushing down a few inches on the handle
- ▶ Weighs 1.55 lb (0.70 kg)

Pole not included.

5214-01 — Gardener Rod Rest 1.25-inch OD

Pole Extensions

Aluminum, carbon fiber or fiberglass extensions



FEATURES & BENEFITS

- ▶ The pole extensions have 5/8 x 11 female threads on

the bottom and 5/8 x 11 male threads on the top to allow more added sections

- ▶ Choose powder-painted aluminum, carbon fiber, or fiberglass

Part No.	OUTSIDE DIAMETER	LENGTH	POLE TYPE	WEIGHS	
5182-001	1 in (25 mm)	3 in (7.62 cm)	Aluminum	0.40 lb (0.18 kg)	
5132-00-ACL	1 in (25 mm)	6 in (15.2 cm)	Aluminum	0.50 lb (0.23 kg)	
5130-01-FLY	1 in (25 mm)	1 ft (30.5 cm)	Aluminum	1.00 lb (0.45 kg)	
5902-00-FLY	1 in (25 mm)	50 cm (19.69 in)	Aluminum	0.70 lb (0.32 kg)	
5131-01-FLY	1 in (25 mm)	2 ft (61 cm)	Aluminum	1.10 lb (0.50 kg)	
5901-00-FLY	1 in (25 mm)	1 meter (39.37 in)	Aluminum	1.10 lb (0.50 kg)	
5110-01-FLY	1 in (25 mm)	4 ft (1.22 m)	Aluminum	1.30 lb (0.59 kg)	
5145-00-FLY	1.25 in (32 mm)	25 cm (9.84 in)	Aluminum	0.90 lb (0.41 kg)	
5130-00-FLY	1.25 in (32 mm)	1 ft (30.5 cm)	Aluminum	1.00 lb (0.45 kg)	
5144-00-FLY	1.25 in (32 mm)	50 cm (19.69 in)	Aluminum	1.00 lb (0.45 kg)	
5131-00-YEL	1.25 in (32 mm)	2 ft (61 cm)	Aluminum	1.10 lb (0.50 kg)	
5143-00-FLY	1.25 in (32 mm)	1 meter (39.37 in)	Aluminum	1.30 lb (0.59 kg)	
5110-00-FLY	1.25 in (32 mm)	4 ft (1.22 m)	Aluminum	1.30 lb (0.59 kg)	
5110-00-RED	1.25 in (32 mm)	4 ft (1.22 m)	Aluminum	1.30 lb (0.59 kg)	
5145-03	1 in (25 mm)	25 cm (9.84 in)	Carbon Fiber	0.35 lb (0.16 kg)	
5145-02	1.25 in (32 mm)	25 cm (9.84 in)	Carbon Fiber	0.35 lb (0.16 kg)	
5144-02	1.25 in (32 mm)	50 cm (19.69 in)	Carbon Fiber	0.50 lb (0.23 kg)	
5143-02	1.25 in (32 mm)	1 meter (39.37 in)	Carbon Fiber	0.70 lb (0.32 kg)	
5130-10	1.25 in (32 mm)	0.20 meter (7.87 in)	Fiberglass	0.34 lb (0.15 kg)	

Imported Range Poles

Contractor Series of Extendible Section Poles

- ▶ Single 4-foot (1.22-m) section range pole
- ▶ 1.13-in (29-mm) outside diameter
- ▶ With brass male/female fittings on all range poles
- ▶ Includes bag (no point included)
- ▶ Weighs 1.50 lb (0.68 kg)



5160-02-WOR — Contractor Series 4-ft Range Pole

- ▶ Two 4-ft (1.22 m) sections creating 8-ft (2.44-m) range pole
- ▶ 1.13-in (29-mm) outside diameter
- ▶ With brass male/female fittings on all range poles
- ▶ Includes point and bag
- ▶ Weighs 3.40 lb (1.54 kg)



5140-02-WOR — Contractor Series 8-ft Range Pole

- ▶ Three 4-foot (1.22-m) sections creating 12-ft (3.66-m) range pole
- ▶ 1.13-in (29-mm) outside diameter
- ▶ With brass male/female fittings on all range poles
- ▶ Includes point and bag
- ▶ Weighs 5.00 lb (2.27 kg)



5150-02-WOR — Contractor Series 12-ft Range Pole

Prism Pole Bipods & Tripods

Prism Pole Bipods And Tripods

- ▶ A surveyor can set up a free-standing GNSS antenna pole or prism pole
- ▶ Poles 1- to 1.25-inch (25.6- to 32-mm) OD attach through the open clamp
- ▶ 1.5-inch (38.1 mm) OD poles can be loaded through the top
- ▶ Legs (independently) extend to 6 feet (1.8 m)
- ▶ Collapses to 43 inches (109 cm)
- ▶ Weighs 4.25 lb (1.93 kg)
- ▶ Order bag 8180-20 and leg clips 5217-30

★ Includes No-Crush Head



- 5217-04-FOR — Original Thumb Release Bipod
- 5217-04-FLY — Original Thumb Release Bipod
- 5217-04-RED — Original Thumb Release Bipod
- 5217-04-YEL — Original Thumb Release Bipod

- ▶ A surveyor can set up a free-standing GNSS antenna pole or prism pole
- ▶ Poles 1- to 1.25-inch (25.6- to 32-mm) OD attach through the open clamp
- ▶ 1.5-inch (38.1 mm) OD poles can be loaded through the top
- ▶ Legs (independently) extend to 6 feet (1.8 m)
- ▶ Collapses to 43 inches (109 cm)
- ▶ Weighs 4.25 lb (1.93 kg)
- ▶ Comes with bag and leg clips for easy transportation

★ Includes No-Crush Head



- 5217-40-FLY — Thumb Release Bipod
- 5217-40-RED — Thumb Release Bipod
- 5217-40-YEL — Thumb Release Bipod

- ▶ This assembly easily converts your existing prism/range pole bipod to a prism/range pole tripod when extra stability is needed!
- ▶ Easy to attach or remove with our "open clamp" design
- ▶ Operation is exactly the same as a one-piece Pole Tripod
- ▶ Same construction as the third leg on a Pole Tripod
- ▶ A good accessory for 5217-04 and 5217-40
- ▶ Weighs 1.85 lbs (0.84 kg)

Bipod and Pole not included.



- 5218-06-FLY — Solo Leg with Clamp
- 5218-06-FOR — Solo Leg with Clamp
- 5218-06-RED — Solo Leg with Clamp
- 5218-06-YEL — Solo Leg with Clamp

- ▶ Carbon Fiber Thumb Release Bipod uses the same design concepts as the SECO aluminum Thumb Release Bipod, but weighs less
- ▶ 1- to 1.25-inch (25.6- to 32-mm) diameter poles attach easily through the open clamp
- ▶ 1.5-inch (38.1-mm) OD poles can be loaded through the top
- ▶ Collapses to 43-inches (109-cm)
- ▶ Legs (independently) extend to 6-feet (1.8-m)
- ▶ Weighs 4.10 lb (1.86 kg)

★ Includes No-Crush Head



- 5219-03 — Carbon Fiber Thumb Release Bipod

- ▶ The Carbon Fiber Thumb Release Tripod features a large 5-lobe soft touch rubber clamping knob, and legs of super strong, lightweight carbon fiber
- ▶ Legs collapses to 43-inches (109-cm)
- ▶ Legs extend to 6-ft (1.8-m)
- ▶ Weighs 4.10 lb (1.86 kg)



- 5219-05 — Carbon Fiber Thumb Release Tripod

- ▶ To upgrade older bipod models, use this upgrade kit
- ▶ Contoured head design prevents crushing of carbon fiber range or prism poles even when excess force is used
- ▶ All metal design is "form fitting" for all popular pole sizes.
- ▶ Weighs 4.25 lb (1.93 kg)



- 5217-072 — Upgrade kit, for any existing SECO bipod to the new head design

Bipods & Tripods

- ▶ This tripod is ideal for use with poles under 24-inches (61-cm) long 1- to 1.5-inch (25.4- to 38.1-mm) diameter poles thread easily through the open clamp on top
- ▶ Legs are fixed at 12-inches (30.5-cm) each
- ▶ Includes stainless steel clamp screw and rubber tips
- ▶ Rod, 5010-00-RED, page 22, not included
- ▶ Weighs 1.30 lb (0.60 kg)



5218-15-ABK — Mini Tripod with 12 inch Legs

- ▶ The Mini Bipod utilizes the same design concepts as the popular 5217-04 bipod, just shorter (see page 28)
- ▶ Poles 1- to 1.25-inch (25.6- to 32-mm) diameter attach easily through the open clamp
- ▶ Poles 1.5-inch (38.1-mm) OD can load through the top
- ▶ Collapses to 25 inches (63.5 cm)
- ▶ Extends to 35 inches (88.9 cm)
- ▶ Leg clip is included (5217-30)
- ▶ Weighs 3.50 lb (1.60 kg)

★ Includes No-Crush Head



5217-05-FOR — Thumb Release Mini Bipod
 5217-05-FLY — Thumb Release Mini Bipod
 5217-05-RED — Thumb Release Mini Bipod
 5217-05-YEL — Thumb Release Mini Bipod

- ▶ The tripod features a ball-and-socket head, which makes leveling a bubble easy
- ▶ Legs extend from 2.62- to 4.17-ft (80-cm to 1.3-m)
- ▶ The rubberized jaws hold a pole (up to 2-inch (51-mm) OD) firmly in place
- ▶ Carrying case is included
- ▶ Weighs 2.65 lb (1.20 kg)

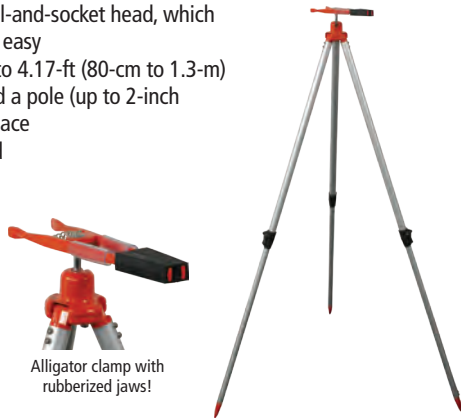

Alligator clamp with rubberized jaws!

5214-00 — Alligator Clamp Prism Pole Tripod

- ▶ The bipod leg clip easily attaches to the base of any 1.25-inch (32-mm) OD prism or antenna pole
- ▶ The bipod legs snap into the clip making the system convenient for transport or storage
- ▶ Ideal for 5217-04 series
- ▶ Can be used for prism pole tripods with combination of 2 units
- ▶ Weighs 0.04 lb (0.02 kg)



5217-30 — Bipod Leg Clip

- ▶ SECO manufactured, not imported
- ▶ Thumb-Release™ Tripods creates free-standing GNSS antenna poles or prism poles
- ▶ The thumb lock design allows adjustment of tension without disassembly of the leg
- ▶ Universal head accommodates poles from 1- to 1.5-inch (25.6- to 38.1-mm) OD
- ▶ Legs extend (independently) to 6-ft (1.8-m)
- ▶ Feature large, smooth, thumb release buttons
- ▶ Constructed of powder-coated aluminum
- ▶ Weighs 6.00 lb (2.60 kg)



5218-02-FLY — Original Thumb Release Tripod
 5218-02-FOR — Original Thumb Release Tripod
 5218-02-RED — Original Thumb Release Tripod
 5218-02-YEL — Original Thumb Release Tripod

- ▶ Thumb-Release™ Tripods creates free-standing GNSS antenna poles or prism poles
- ▶ The thumb lock design allows adjustment of tension without disassembly of the leg
- ▶ Universal head accommodates poles from 1- to 1.5-inch (25.6- to 38.1-mm) OD
- ▶ Legs extend (independently) to 6-ft (1.8-m)
- ▶ Feature large, smooth, thumb release buttons
- ▶ Constructed of powder-coated aluminum
- ▶ Weighs 6.00 lb (2.60 kg)



5218-40-FLY — Thumb Release Tripod
 5218-40-RED — Thumb Release Tripod
 5218-40-YEL — Thumb Release Tripod

PRISM basics

Prism Offsets

- ▶ Corner cube prisms (or retroreflectors) used with electronic distance measuring (EDM) instruments have an offset due to the fact that the transmitted light beam from the EDM takes longer to enter and exit the prism. This longer time translates to a longer distance measured. This distance is corrected by using an 'offset' and/ or positioning the prism in relationship to the plumb line of the prism holder. The offset is determined by multiplying the height of the prism by the refractive index of the glass used. Common offsets are 0, -17.5 mm, -30 mm, -34 mm, and -40 mm.

Nodal Offsets

- ▶ A nodal offset is defined by the relationship of the prism holder and prism that places the optical center of the prism on the plumb line of the holder. This offset is the most advantageous at close range work when the apex or center of the prism is used as a pointing target for vertical and horizontal angle measurement. Every prism has a nodal offset. Prisms and holders that are not in the nodal position however, can cause angular errors when using the prism apex as a target if it is not perfectly pointed toward the measuring instrument.
- ▶ To reduce pointing errors, several SECO prism assemblies are designed with a nodal point alignment at -17.5 (for 25 mm prisms) or -40 mm offset (for 62 mm prisms). See illustration at right.
- ▶ Commonly, the best reading of the beam is achieved when the prism face is perpendicular to the incoming beam for a parallel return. Unfortunately, ideal alignment is not always achieved in the field.
- ▶ To compensate for pointing errors, nodal point alignment minimizes the error associated with misalignments (two illustrations below).

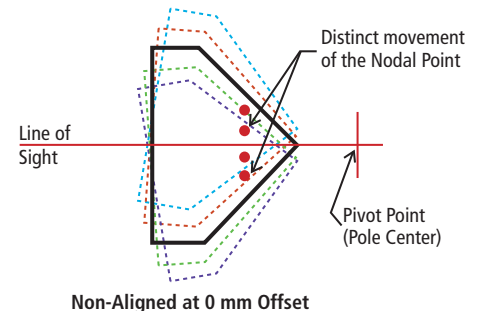
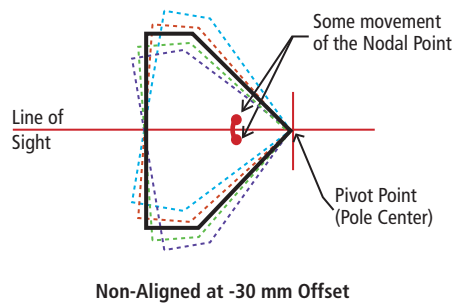
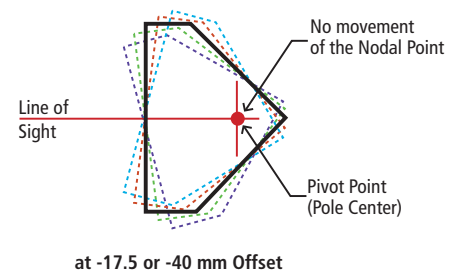

Prism Range

- ▶ Corner cube prisms redirect the measuring beam back to the EDM for signal processing.
- ▶ There are two main factors for good range measurement: prism diameter and beam deviation.
- ▶ If the beam deviation is not accurate enough, the returned beam will miss the EDM entirely.
- ▶ This occurs mainly near the maximum range of the EDM (check with your manufacturer).
- ▶ SECO standard prisms are <5 seconds. Higher accuracy prisms are also available.

Prism Holder Accuracy

- ▶ Prism accuracy is determined by the physical location of the prism in its canister and then to its holder. SECO prism accuracy is 1 mm or less.

Premier Prism Assemblies Copper

62 mm Rear Screw Lock



FEATURES & BENEFITS

- ▶ Tilting holder is anodized aluminum and features a
- ▶ 62 mm copper-coated canister prism
- ▶ Features an improved brass locking thumb screw design and a light but durable metal holder
- ▶ Tilting axis height is 115 mm
- ▶ Mounted in either 0 or
- ▶ -30 mm offset positions

PART NO.	TARGET COLOR	TARGET SIZE	Weights	
6402-02-FLB	Flo Yellow with Black	6 x 9 in	1.75 lb (0.79 kg)	
6402-02-FOB	Flo Orange with Black	6 x 9 in	1.75 lb (0.79 kg)	
6402-02-YLB	Yellow with Black	6 x 9 in	1.75 lb (0.79 kg)	
6422-02-FOB	Flo Orange with Black	5.5 x 7 in	1.59 lb (0.72 kg)	
6422-02-YLB	Yellow with Black	5.5 x 7 in	1.59 lb (0.72 kg)	

Premier Prism Assemblies Silver

62 mm Rear Lever Lock



FEATURES & BENEFITS

- ▶ The heavy-duty 62 mm silver-coated prism is sealed in a strong canister with an o-ring to prevent water and dust from getting inside
- ▶ Incorporates a simple rear-locking stainless steel lever mechanism that is easy to set while adjusting the prism and target tilt
- ▶ Prism can be mounted in either 0 or -30 mm offset positions
- ▶ 115 mm tilting axis height
- ▶ Two target sizes and three color combinations are available

PART NO.	TARGET COLOR	TARGET SIZE	Weights	
6402-20-FLB	Flo Yellow with Black	6 x 9 in	1.75 lb (0.79 kg)	
6402-20-FOB	Flo Orange with Black	6 x 9 in	1.75 lb (0.79 kg)	
6402-20-YLB	Yellow with Black	6 x 9 in	1.75 lb (0.79 kg)	
6422-20-YLB	Yellow with Black	5.56 x 7.13 in	1.59 lb (0.72 kg)	

Prism Premier Assemblies Strobe

62 mm blinking strobe prism assembly



FEATURES & BENEFITS

- ▶ Combines the premier target and holder with a strobe prism
- ▶ Features a blinking strobe prism with an LED light that flashes every 0.5-second
- ▶ This prism can be purchased separately (6416-00, page 39)
- ▶ Perfect for low light conditions
- ▶ Tilting axis height is 115 mm
- ▶ Weighs 1.35 lb (0.62 kg)

PART NO.	TARGET COLOR	TARGET SIZE	
6402-03-FLB	Flo Yellow with Black	6 x 9 in	
6402-03-FOB	Flo Orange with Black	6 x 9 in	
6402-03-YLB	Yellow with Black	6 x 9 in	

Premier Prism Assemblies

-35 mm to work with Trimble and Spectra Geospatial Total Stations



FEATURES & BENEFITS

- ▶ Features a -35 mm offset and a prism accuracy of <5 seconds
- ▶ Mounting base features standard female 5/8 x 11 threads
- ▶ Tilting holder is constructed of anodized aluminum
- ▶ Height of the prism in the holder is 135 mm
- ▶ 62 mm silver-coated prism is encased in a heavy-duty canister with M20 threads
- ▶ Weighs 1.75 lb (0.80 kg)
- ▶ Nodal

Part No.	TARGET COLOR	TARGET SIZE
6402-05-FOB	Flo Orange with Black	6 x 9 in
6402-05-YLB (shown)	Yellow with Black	6 x 9 in

Premier Prism Assemblies

-30 and 0 mm to work with Nikon, Topcon & Sokkia Total Stations



FEATURES & BENEFITS

- ▶ 62 mm copper-coated prism is encased in a heavy-duty canister with M20 threads
- ▶ Features a -30 and 0 mm offset
- ▶ Height of the prism in the holder is 100 mm
- ▶ Tilting holder is constructed of anodized aluminum
- ▶ Prism accuracy of <5 seconds
- ▶ Mounting base features standard female 5/8 x 11 threads
- ▶ Weighs 1.75 lb (0.80 kg)

Part No.	TARGET COLOR	TARGET SIZE
6402-06-FLB	Flo Yellow with Black	6 x 9 in
6402-06-FOB	Flo Orange with Black	6 x 9 in
6402-06-YLB (shown)	Yellow with Black	6 x 9 in

Standard Prism Assembly

Contractor Series 62 mm prism assembly



FEATURES & BENEFITS

- ▶ Features a 62 mm copper-coated canister type prism
- ▶ Water-resistant and has a M20 universal mounting thread
- ▶ Tilting holder is powder-painted die cast aluminum
- ▶ Uses a simple but proven locking system
- ▶ Target size 5.5" x 7"
- ▶ Mounted in either 0 or -30 mm offset positions
- ▶ Tilting axis height is 115 mm
- ▶ Weighs 1.35 lb (0.62 kg)

- 6402-10-FOB — Prism Assembly in Flo Orange with Black
- 6402-10-FLB — Prism Assembly in Flo Yellow with Black
- 6402-10-YLB — Prism Assembly in Yellow with Black

360 PRISM

Lightweight and inexpensive, made to be set up and left for extended periods



FEATURES & BENEFITS

- ▶ Compatible with Leica instruments and offsets
- ▶ Prism accuracy <5 seconds

- ▶ Pointing accuracy <2mm to face of prism
- ▶ Range up to 2000ft(600M)
- ▶ Prism Height 86mm
- ▶ Push Button Quick Release

- ▶ Male 5/8-11 thread on top
- ▶ Carrying case included, hard and soft case
- ▶ Weight 1.25 lb (0.6kg)



6406-01 — PRISM, 360, 86MM, +23.1MM PC

MINI 360 PRISM KIT

Lightweight and inexpensive, made to be set up and left for extended periods



FEATURES & BENEFITS

- ▶ Compatible with Leica instruments and offsets
- ▶ Prism accuracy <5 seconds
- ▶ Prism Offset +30 mm

- ▶ Sliding Circular Vial, sensitivity 40 minutes
- ▶ Includes 4 30cm extensions with 5cm point, 1/4-20 threads
- ▶ Carrying case included

- ▶ Ceiling hook included
- ▶ Kit weight 1.2 lbs (0.55kg)

6406-02 — PRISM, MINI 360, KIT, +30mm PC

Prism Assembly: Tilting Single

Swiss Style Prism Assembly



FEATURES & BENEFITS

- ▶ Includes copper-coated 62 mm prism (6411-02)

- ▶ -30 mm offset aluminum prism holder, sealed with a rugged corrosion-proof electrostatic powder paint coating

- ▶ Target Size: 4.75" x 4.75"
- ▶ 115 mm prism height
- ▶ Weighs 1.50 lb (0.68 kg)

6440-00-FOR — Single Prism Tilting Assembly

Prism: Sliding, Tilt Reflector

Use with Prism Pole or Site Rod



FEATURES & BENEFITS

- ▶ Attaches to the bottom of the graduated section of a pole so heights can be taken close to the ground
- ▶ Includes a, large, 2.5 inch (63.5 mm) silver-coated prism with

- protective rubber ring
- ▶ 0 offset and 40-min leveling vial
- ▶ Tilts in 15° increments, spring locked
- ▶ Large easy-to-use clamping knob

- ▶ Targets made of fluorescent-yellow translucent polycarbonate
- ▶ Use with prism pole or site rod
- ▶ Weighs 0.81 lb (0.37 kg)

6455-00 — Sliding Prism with Tilting Reflector

Prism Assembly: Tilting Triple

Complete system is perfect for longer distances



FEATURES & BENEFITS

- ▶ Made from orange polycarbonate with metal inserts and an aluminum yoke
- ▶ Holds one to three prisms, is compatible with most screw-in prisms
- ▶ Has a peep sight for pointing the holder, perfect for longer distances
- ▶ Includes three sealed copper-coated 62 mm prisms in black canisters (6411-02-BLK)
- ▶ 0 and -30 mm prism offset
- ▶ Target size 12.6 in wide x 11.42 in (32 cm wide x 29 cm tall)
- ▶ Weighs 2.70 lb (1.23 kg)

6341-00 — Tilting Triple Prism Assembly
6341-11 — Tilting Triple Prism Target



Prism Assembly: Nodal Point

62 mm can be offset to -40 mm



FEATURES & BENEFITS

- ▶ The import assembly features a polycarbonate holder, three prism offset positions, 0, -30 and -40 (nodal)
- ▶ The 62 mm prism is silver-coated and has a <5-second accuracy
- ▶ The height to center of glass: 0.33 ft (100 mm)
- ▶ The reversible non-tilting metal target comes in orange & white and black & white
- ▶ Prism Target size 20 cm x 18.5 cm (7.87 in x 7.28 in)
- ▶ Weighs 1.45 lb (0.66 kg)

6400-10 — Nodal Point 62 mm Prism Assembly



Prism Assembly: Nodal Point

-34 Swiss Style Prism Assembly



FEATURES & BENEFITS

- ▶ -34 mm offset prism
- ▶ Quick Release
- ▶ 62 mm diameter copper coated prism
- ▶ 86 mm Height
- ▶ Weighs 0.92 lb (0.42 kg)

6406-00 — Nodal Point 62 mm Prism Assembly



Prism Assembly: Nodal Point

Eclipse 62 mm can be offset to -40 mm or -30 mm



FEATURES & BENEFITS

- ▶ The Eclipse™ prism assembly features a water-resistant, nitrogen-charged, 62 mm target (yellow and black on the reverse)
- ▶ Can be set at a -40 mm, which offers optimal angle measurements, even when tilting in either the horizontal or the vertical axis
- ▶ Height to center of glass: 0.38 ft (115 mm)
- ▶ -30 mm adapter is included
- ▶ Weighs 1.15 lb (0.52 kg)

6400-00 — Eclipse 62 mm Prism Nodal Point Assembly
6410-00 — -30, -40 Offset Eclipse Prism Holder



Prisms: Mini and Stakeout

- ▶ Here's a versatile prism system in a small package
- ▶ Assembly features a 25 mm copper-coated prism, for fog prevention, a tilting holder, with friction axis, 0 or -30 mm offset. Can be mounted on a prism pole or tribrach at three heights: 70 mm, 100 mm, 115 mm, or can be hand-held using the plumb bob bracket or with S-hook for quick attachment to plumb bob
- ▶ Includes a 40-minute adjustable circular center or side mounted vial
- ▶ Also included a point for stake-out work, and a system bag with belt loop
- ▶ Powder painted flo orange
- ▶ Weighs 0.34 lb (0.15 kg)



- ▶ The Mini Prism Mono Pod Kit forms a stable base with your 6000-Series Mini Prism
- ▶ Prism not included – sold separately, 6405-10-FOR
- ▶ Kit is easy to set up and can be used by just one person
- ▶ Ideal for: construction surveys, inspections, as built, and many other applications
- ▶ Add a standard 5/8 x 11 extension to the kit to achieve heights to four feet
- ▶ Weighs 2.25 lb (1.02 kg)



5216-00 — Mini Prism Mono Pod Kit



6200-10-FOR — Mini Prism System with Center Vial
6200-11-FOR — Mini Prism System with Side Vial (shown)



- ▶ The Mini Stakeout Prism features a 25 mm, copper-coated prism, aluminum double yoke construction with tilting coaxial target
- ▶ Two on-board 130-minute vials — top and bottom
- ▶ Includes replaceable plumb bob point
- ▶ 0 and -30 mm offset
- ▶ Includes carrying case
- ▶ Weighs 0.62 lb (0.28 kg)



- ▶ The 25 mm Stakeout Prism Assembly features 'site cones' that improve vertical angle pointing — the site cones double as tilting-axis lock knobs
- ▶ Adjustable 40-min vial is mounted on the front side and is easy to see and simple to adjust
- ▶ This mini prism is a zero-offset if you reverse the prism
- ▶ Assembly features a 25 mm copper-coated prism, for fog prevention, a tilting holder, with friction axis, 0 or -30 mm offset. Can be mounted on a prism pole or tribrach at three heights: 70 mm, 100 mm, 115 mm, or can be hand-held using the plumb bob bracket or with S-hook for quick attachment to plumb bob
- ▶ Prism height 50 mm to female 5/8
- ▶ Prism height 100mm to Point
- ▶ Includes carrying case
- ▶ Weighs 0.30 lb (0.14 kg)



6405-01-FOR — 25 mm Stakeout Prism Assembly – Flo Orange
6405-01-FLY — 25 mm Stakeout Prism Assembly – Flo Yellow



6405-10-FOR — 25 mm Stakeout Prism Assembly



- ▶ The white site cones on X and Y axis of the assembly help improve centering of your instrument's crosshairs for vertical and horizontal pointing
- ▶ Used in four height configurations: 50 mm, 100 mm, 115 mm and 150 mm, top or bottom of the pole, handheld, or tribrach mounted
- ▶ Choose between 0/-30 mm or -17.5 mm (nodal) offsets
- ▶ Weighs 0.80 lb (0.36 kg), 1.30 lb (0.59 kg) with heavy-duty point



6405-11-FLY

- ▶ The 25 mm Stakeout Prism Assembly features 'site cones' that improve vertical angle pointing — the site cones double as tilting-axis lock knobs
- ▶ Adjustable 40-min vial is mounted on the front side and is easy to see and simple to adjust
- ▶ -17.5 mm (nodal) offset
- ▶ Includes carrying case
- ▶ Weighs 0.30 lb (0.14 kg)



6405-11-FOR — Stakeout Mini Prism Kit - 0 / -30 mm offset – Flo Orange
6405-11-FLY — Stakeout Mini Prism Kit - 0 / -30 mm offset – Flo Yellow
6405-13-FLY — Stakeout Mini Prism Kit – Nodal -17.5 mm offset



6405-12-FOR — 25 mm Stakeout Prism Assembly



Prism System: Tilting Mini



FEATURES & BENEFITS

- ▶ The Eclipse™ mini system includes: a Mini Tilting Prism;

plumb bob attachment; Mini Bob Prism Mount; Point, and Belt Case

- ▶ 0 and -30 offsets
- ▶ Black hardware
- ▶ Case included
- ▶ Weighs 0.30 lb (0.14 kg)

6450-00-BLK — Tilting Mini Prism System 

Prisms: Sliding and Pin Pole Kits



Site cones double as locks

- ▶ This Euro-Style Pole System features a 40-minute adjustable vial, white sight cones and a 5/8 x 11 adapter for standard prism poles (for height of 115 mm)
- ▶ All 30 cm sections are anodized aluminum
- ▶ A carrying case is also included
- ▶ Weighs 1.60 lb (0.73 kg)



- ▶ The sliding 360° Prism Kit allows for quick shots in confined line-of-sight situations and allows for more precise height measurements. Easily find the right shot at the right height!
- ▶ The included adapter allows for easy connection to controllers, making it great for handheld use. Use one or all four pin pole sections for the height/portability you need.
- ▶ The prism assembly slides on 9-mm-diameter solid steel pin poles, graduated in cm
- ▶ The four solid yellow pole sections have cm grooves that the ball-detent in the prism assembly will automatically center on
- ▶ Replaceable stainless steel point
- ▶ The assembly is composed of seven 12.7- mm diameter silver-coated mini-prisms in a 360° configuration
- ▶ Prism offset is +2mm
- ▶ Adjustable circular vial is 40-minute
- ▶ Clamp screw locks the prism assembly anywhere on the pole
- ▶ Data collector adapter and carrying case are included
- ▶ Weighs 1.70 lbs (0.77 kg)



Part No.	Offset	
5910-01-ARD	0 / -30 offset	
5910-02-ARD	-17.5 offset (Nodal)	

5910-24 — Sliding 360° Prism Kit 

- ▶ Prism assembly slides up and down the pin pole
- ▶ Features a 25 mm, 0 offset silver-coated prism and a high quality aluminum holder
- ▶ Foot kit model includes four 1-foot pole sections with 1/2 foot markings
- ▶ Metric kit includes four 30.0 cm pole sections with a 15 cm mark
- ▶ Site cones double as locks
- ▶ 40-minute adjustable vial on prism
- ▶ Prism includes an adapter so it can be used on any pole or tribrach adapter with 5/8 x 11 threads
- ▶ A system bag is also included
- ▶ Weighs 1.40 lb (0.63 kg)

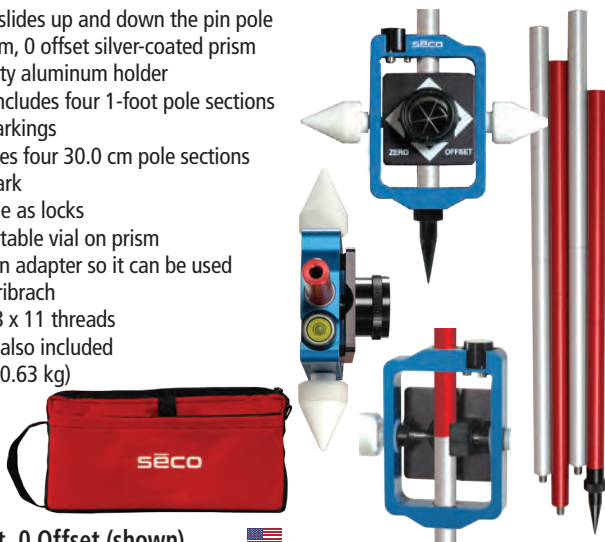

5910-05 — Feet, 0 Offset (shown) 
5910-06 — Metric, 0 offset 

- ▶ The 12.2 mm OD pin pole features three sections - each 60 cm in length to achieve 5.91 ft (1.8 m); each color section (red or white) is 10 cm in length
- ▶ An adjustable 40-minute circular vial is built in to the prism holder
- ▶ 25 mm sliding prism system features a silver-coated prism with a 0 offset
- ▶ The holder easily slides up and down the pole, the knobs lock in height and tilt – they also double as vertical angle targets
- ▶ Other features include a replaceable stainless steel point on the pole, accessory kit with plumb bob hook and cone for attachment to the prism for handheld applications
- ▶ System Bag included
- ▶ Weighs 1.95 lb (0.90 kg)

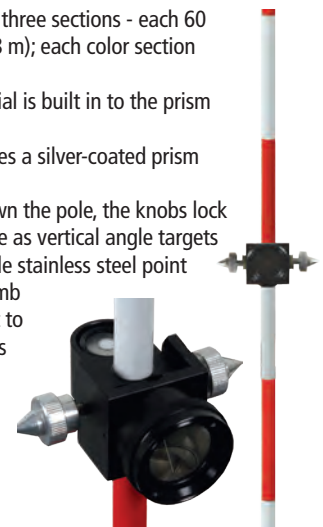

6600-10 — Pin Pole with Sliding 25 mm Prism System 

Walleye Prism System



FEATURES & BENEFITS

- ▶ Lightweight and inexpensive, made to be set up and left for extended periods
- ▶ Features & Benefits
- ▶ The Walleye™ Prism System accommodates a full size 62 mm prism (6411-03-BLK) for long range applications or when a larger prism is needed
- ▶ Rain hood helps keep the

- prism clean to ensure continual measurements over a long measuring cycle
- ▶ The flat bottom of the L-Bracket is a large 2.3 x 3.4 inch (58.24 x 86.36 mm) with five holes for mounting to a variety of surfaces
- ▶ Components available individually so you can configure your specific needs

- ▶ The system is compatible with all M20 screw-in type prism canisters
- ▶ Center pivot hole is 3/8 inch (9.5 mm), the four screw holes are 4.5 mm OD
- ▶ Features include a -40 mm offset, ± 2 mm, ability to pivot in two axes, stainless-steel locking
- ▶ System weighs 1.55 lb (0.70 kg)

Part No.	Description	
6603-00	Complete Walleye Prism System with Prism and 5/8 x 11 Adapter	
6603-01	Complete Walleye Prism System with Prism and M8 Adapter	
6603-00-050	L-Bracket Assembly Only	
6603-00-005-TMB	Rain Hood Only	
6603-01-051	M8 Adapter with Screws and Washer	

Monitoring Survey Targets

6605 series – Copper-coated Mini-prism with 360° Rotation & Magnetic attachment

- ▶ Twistable, 25.4 mm mini-prism made with a rugged plastic housing system.
- ▶ Easy to align precisely with any measuring instrument.
- ▶ Perfect target to monitor bridges, rail lines, buildings and other structures quickly and accurately.
- ▶ Multiple mounting solutions: magnetic system, mounting adhesives or screws

Product characteristics:

- ▶ Copper coated mini prism. Diameter: 25.4 mm with a tolerance of +/- 0.2 mm
- ▶ Height of the 25.4 mm prism: 13.125 mm
- ▶ Accuracy is 5 arc sec with a tolerance of +/- 2arc
- ▶ Offset -16.9 (minus 16.9), height of tilting axis: 45 mm
- ▶ Recommended measurement range: 600 meter
- ▶ Two color available: Red or Grey



6606 series – Retro Reflective Survey Targets

- ▶ Ideal for back sights, check shots, elevation references and monitoring situations.
- ▶ Very affordable solution to save crew time, improve data, and feel more secure about construction layout.

Survey targets range:

- ▶ Target reflectors w/ cross hair 30 x 30 mm: range approx. 80 m (262 ft)
- ▶ Target reflectors w/ cross hair 40 x 40 mm: range approx. 100 m (328 ft)
- ▶ Target reflectors w/ cross hair 60 x 60 mm: range approx. 120 m (393 ft)



6604 series – Retro Reflective Target with 360° Rotation

- ▶ Twistable, 30 x 30 mm reflective target made with a rugged plastic housing system which can be rotated 360° for unlimited tilting and turning options.
- ▶ The target can easily be glued to difficult surfaces such as glass and marble facades, historic buildings, steel girders, rail lines, gas and oil pipelines, etc. or can be attached using bolts and screws.

Product characteristics:

- ▶ 30 x 30 mm retro reflective target with cross hairs
- ▶ Accuracy is 5 arc sec with a tolerance of +/- 2arc
- ▶ Offset 0, height of tilting axis: 45 mm
- ▶ Recommended measurement range: 80 meter
- ▶ Two color available: Red or Grey



Part No.	M2M description	PRISM BACKING	
6604-20-R	30mm swivel survey Target	COPPER	
6604-20-G	30mm swivel survey Target	COPPER	
6605-60M-R	MP swivel survey Target	COPPER	
6605-60M-G	MP swivel survey Target	COPPER	
6606-04-30	30X40mm reflective target	N/A	
6606-04-40	40X40mm reflective target	N/A	
6606-04-60	60X60mm reflective target	N/A	

Monitoring Accessories

Aluminum plates for anchoring

- ▶ Wedge-shaped aluminum plate features a 12.5 mm prism
- ▶ Plate can be fixed with special adhesive on to the pavement
- ▶ Dimensions: 10 x 10 x 2 cm (3.94 x 3.94 x 0.79 inches)
- ▶ Weighs 0.62 lb (0.28 kg)



4 520 800 — 12.5 mm Street-Mountable Building Monitoring Prism System

- ▶ Anodized aluminum plate
- ▶ Three key holes for screws to mount the plate
- ▶ With 5/8 x 11 threaded stud for Tribrach adapter centered on the plate
- ▶ Weighs 1.81 lb (0.82 kg)



See Drawing for Installation Data

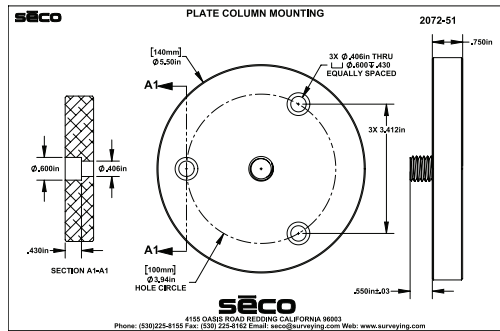

2072-51 — Screw Mounting Column Plate

- ▶ Anodized aluminum plate
- ▶ The three bottom anchor bolts are embedded in concrete during installation
- ▶ With 5/8 x 11 threaded stud for Tribrach adapter centered on the plate
- ▶ Weighs 2.29 lb (1.04 kg)



See Drawing for Installation Data

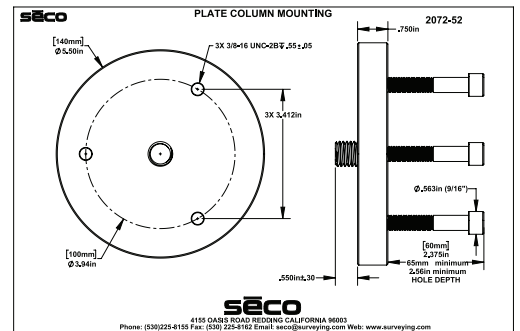

2072-52 — Column Plate

Mini Prisms

Lightweight and inexpensive, made to be set up and left for extended periods

- ▶ Lightweight and inexpensive, made to be set up and left for extended periods
- ▶ Features a 60 mm diamond pattern sheeting and a 2 mm offset
- ▶ Use for distances up to 492 ft (150 m)
- ▶ Feature an 86 mm height
- ▶ Fits Swiss-style male tips or Quick Release adapters
- ▶ Weighs 0.17 lb (0.08 kg)



6600-01 — Small Tilting Mini Prism - Diamond Pattern

- ▶ Features a 60 mm diamond pattern with Crosshairs sheeting and a 2 mm offset
- ▶ Use for distances up to 492 ft (150 m)
- ▶ Features an 86 mm height
- ▶ Fits Swiss-style male tips or Quick Release adapters
- ▶ Weighs 0.15 lb (0.07 kg)



6600-03 — Diamond Pattern with Crosshairs

- ▶ Use for distances up to 492 ft (150 m)
- ▶ Features a 25 mm mini prism for longer distances up to 2,000 ft (609.6 m)
- ▶ Features an 86 mm height
- ▶ Fits Swiss-style male tips or Quick Release adapters
- ▶ Offset 17.5 mm
- ▶ Weighs 0.23 lb (0.10 kg)



6600-04 — Small Tilting 25 mm Mini Prism

- ▶ This Prism series is ideal for deformation and mining surveys or wherever permanent mounting is needed
- ▶ This design makes mounting and pointing easy on uneven surfaces
- ▶ Mounting Arm allows tilt up to 240 degrees and Prism mount allows 360 degrees rotation
- ▶ Rechargeable battery
- ▶ The two Mounting holes are spaced 1.75" (44.4mm) apart
- ▶ Mounting holes are 0.328" (8.3mm) diameter
- ▶ Two Prism mounting holes, spaced 1.75" (44.4mm) apart
- ▶ Pivot and Prism mounting bolts are 8MM stainless steel with lock washers
- ▶ 6mm Hex wrench included
- ▶ Rain Hood included with 6603-05



- ▶ The 25 mm copper-coated prism is permanently bonded to the holder making it water and dust proof
- ▶ Features a black anodized aluminum holder
- ▶ Tilting screw uses an 8 mm hex wrench to loosen and tighten it
- ▶ Mounting hole is 10.3 mm (0.406 inch) in diameter
- ▶ Design makes mounting and pointing simple
- ▶ Centering accuracy 1.5 mm
- ▶ -25.5mm, Leica +8.9mm
- ▶ Weighs 0.45 lb (0.20 kg)



6600-02 — 25 mm 'L-Bar' Copper-Coated Mini Prism

- ▶ The 25 mm silver-coated prism is permanently bonded to the holder making it water and dust proof
- ▶ Features a black anodized aluminum holder
- ▶ Tilting screw uses an 8 mm hex wrench to loosen and tighten it
- ▶ Mounting hole is 10.3 mm (0.406 inch) in diameter
- ▶ Design makes mounting and pointing simple
- ▶ Centering accuracy 1.5 mm
- ▶ -25.5mm, Leica +8.9mm
- ▶ Weighs 0.45 lb (0.20 kg)



6600-05 — 25 mm 'L-Bar' Silver-Coated Mini Prism

Part No.	PRISM SIZE	COATED	WEIGHT
6603-05	62 mm	Silver	1.15 lbs (0.52 kg)
6603-06	25 mm	Copper	0.50 lbs (0.23 kg)

Quick Release Adapter

Adapter for mini prisms



FEATURES & BENEFITS

- ▶ Makes the 6600-01, -03, -04 (page 38) compatible with "BW"

Pipe Threads G3/8", but easily threads on to male 5/8-11NC Threads

- ▶ For Swiss-style

6600-01-001 — M16 x 1-6H



Prism: Dual Adjustable

Allows accurate measurements from two or more directions or stations



FEATURES & BENEFITS

- ▶ For mining, tunneling, monitoring and rail
- ▶ Minimal horizontal angle is 84° (Hex tool included)
- ▶ Compatible with standard surveying 5/8 x 11 accessories

- ▶ Holders can be stacked for more than two prisms or an GNSS Receiver can be connected on the top 5/8 x 11 stud so an GNSS measurement can also be made

- ▶ Includes two 62 mm silver coated, water-resistant prisms, accuracy < 2 arc seconds
- ▶ Prism holder is machined from 303 stainless-steel
- ▶ Zero (0) prism offset, ±1 mm
- ▶ Weighs 2.60 lb (1.18 kg)

6603-03 — Adjustable Dual Prism



Quick Release Adapters

Lightweight and inexpensive, made to be set up and left for extended periods



FEATURES & BENEFITS

- ▶ 6601-Series Quick Release Adapters are made of T-303

stainless steel with machined threads that attach to corresponding Anchor Bolts or

- the 6602-Series rebar bolts (see page 60)
- ▶ Weighs 0.10 lb (0.05 kg)

- 6601-01 — 1/4 x 20 Threads
- 6601-02 — 3/8 x 16 Threads
- 6601-03 — M8 Threads
- 6601-04 — M12 Threads



Prism Assembly Components

Customize your own prism solution

- ▶ 62 mm Nitrogen filled prism with hermetically sealed canister
- ▶ Features <5-second accuracy



6411-00

- ▶ 62 mm copper-coated prism with sealed canister
- ▶ Features <5-second accuracy



6411-02-BLK

- ▶ 62 mm silver-coated prism with heavy-duty sealed canister
- ▶ Features <5-second accuracy



6411-03-BLK

- ▶ 62 mm silver-coated prism with heavy-duty sealed-canister
- ▶ Features <2-second accuracy



6411-04-BLK

- ▶ 62 mm silver-coated strobe prism
- ▶ Features 0.5-second flash
- ▶ Sanyo CR 1/3N Battery



6416-00

- ▶ 25 mm copper-coated prism in a canister
- ▶ Weighs 0.06 lb (0.03 kg)



6020-01

- ▶ 25 mm silver-coated prism in a canister
- ▶ Weighs 0.06 lb (0.03 kg)



6020-02

Single Prism Traverse Kit



FEATURES & BENEFITS

- ▶ Includes a 62 mm prism with silver-coated canister (6400-10, see page 34)
- ▶ The adjustable (and reversible) tilt target has a sighting collimator for precise pointing and has
 - ▶ 0, -30, and -40 offsets
- ▶ The kit comes with a rotating tribrach adapter (2153-10, see page 41) that is compatible with all prisms with a 24.9 mm bayonet base
- ▶ Features a 2.5X twist focus optical plummet and a 60-second adjustable
 - ▶ plate vial
 - ▶ Prism has <5 arc seconds angle deviation
 - ▶ The adapter has a precision machined axis that rotates 360°
- ▶ The height is 180 to 200 mm and over the point accuracy is 0.5 mm at 1.5 m
- ▶ Also included is a tribrach (2153-04, see page 41) which features three screw-leveling with center line, an 8-minute circular vial, and 5/8 x 11 base thread
- ▶ Includes hard shell case
- ▶ Weighs 9.95 lb (4.51 kg)

2159-01-BLK — Single Prism Traverse Kit

2159-050 — Hard Shell Traverse Carrying Case (included in kit or sold separately)



Precision Traverse Kit for 155 mm Heights

For Nikon Nivo™ XF, XS and Trimble C3, C5 M3 Total Stations



FEATURES & BENEFITS

- ▶ Preset to a 155 mm height making it compatible with Nikon NIVO™ Series Total Stations
- ▶ Kit includes a 62 mm prism assembly
- ▶ Prism has <5 arc seconds angle deviation and a silver-coated prism to resist fogging
- ▶ Includes rotating tribrach adapter with a 2.5X pull focus optical plummet and a 45-second adjustable plate vial
- ▶ Adapter has a precision machined axis that rotates 360°
- ▶ Tilt target has 0 or -30 offsets
- ▶ Over the point accuracy is 0.5 mm at 1.5 meters
- ▶ Also included is a (2153-04, see page 41) tribrach which features three-screw-leveling with center line, an 8-minute circular vial, and 5/8 x 11 base thread
- ▶ Kit comes in a bright orange, hard shell carrying case (2159-050, see above) which features high density foam inserts, nickel plated latches and backpack straps
- ▶ Weighs 9.95 lb (4.51 kg)

2159-04-BLK — Precision Traverse Kit for 155 mm Heights



Tribrachs & Adapters

Contractor-series tribrachs and adapters

- ▶ Bright 650-nm focused red laser dot
- ▶ Circular vial w/ 8-minute sensitivity
- ▶ Standard three-prong forced centering with center lines
- ▶ Included is a standard 3 volt CR2 lithium battery
- ▶ Weighs 1.65 lb (0.75 kg)
- ▶ Laser class 2
- ▶ These tribrachs do not fit Trimble "S6" Series Instruments



2153-02-BLK — Laser Tribrach



- ▶ The Optical Plummet Twist Focus Tribrach features twist focus (2.5X mag) and leveling screws with center line
- ▶ Features an 8-min vial, three-prong forced centering and a 5/8 x 11 base
- ▶ Tribrach has a focusing range of 1.5 to 50 ft (0.5 to 15 m)
- ▶ These tribrachs do not fit Trimble "S" Series Instruments
- ▶ Weighs 1.85 lb (0.84 kg)



2152-04-BLK — Tribrach with Optical Plummet
2153-04-BLK — Tribrach w/o Optical Plummet



- ▶ Allows adjusting of prism height by moving the threaded brass insert in the adapter
- ▶ Fits all tribrachs
- ▶ Weighs 1.91 lb (0.87 kg)
- ▶ 50-75 mm



2071-00 — Prism H.T. Adapter



- ▶ This adapts retro prisms to Swiss style tribrachs and has a removable Zeiss plug and locking screw
- ▶ Fits all tribrachs
- ▶ Weighs 1.75 lb (0.80 kg)
- ▶ Height 34.5 mm



2070-00 — Rotating Tribrach Adapter



- ▶ This rotating friction top tribrach adapter allows the prism to be pointed after installation in the tribrach
- ▶ Fits all tribrachs
- ▶ Weighs 0.90 lb (0.41 kg)
- ▶ Height 32 mm



2020-00 — Rotating Tribrach Adjuster



- ▶ Use adapter for mounting retro prisms and tripod mounted target systems
- ▶ Fits all tribrachs
- ▶ Weighs 0.50 lb (0.23 kg)
- ▶ Height 24.5 mm



2010-00 — Fixed Tribrach Adapter



- ▶ Use for adjusting optical plummet tribrachs and tribrach bubbles
- ▶ Machined black anodized aluminum features a 2-minute bubble
- ▶ Weighs 1.30 lb (0.59 kg)



2002-00 — Tribrach Adjuster



- ▶ Check and adjusting optical plummet tribrachs in the office
- ▶ Precision-machined, black anodized aluminum
- ▶ Weighs 0.70 lb (0.32 kg)

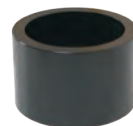

2001-00 — Tribrach Adjusting Cylinder



European Style Tribrach

Choose with or without Optical Plummet



FEATURES & BENEFITS

- ▶ This tribrach features 2X magnification and a twist focus
- ▶ Its reticule is composed of two small concentric circles

- ▶ With a sighting distance of 0.3 m to 15 m, the tribrach has an accuracy of 0.5 mm per 1.5 m
- ▶ Locking forced-centering knob and a 5/8 x 11 base and an 8-minute circular vial

- ▶ Choose with or without an optical plummet
- ▶ Weighs 1.55 lb (0.70 kg)

2152-05-BLK — European-Style Tribrach with Optical Plummet



Traverse Tribrach Adapter

Compatible with all 24.9 mm bayonet base prisms



2153-10-051 Quick Release Adapter



2153-10-050 Male 5/8 x 11 Adapter

FEATURES & BENEFITS

- ▶ The optical plummet is twist-focus with 2.5X magnification
- ▶ 60-second adjustable plate vial

- ▶ Precision-machined axis rotates 360°
- ▶ Compatible with all prisms with a 24.9 mm bayonet base

- ▶ The adjustable height is 100 to 120 mm — fits all standard three-prong tribrachs
- ▶ Over point accuracy is 0.5 mm at 1.5 m
- ▶ Weighs 1.70 lb (0.77 kg)

2153-10-BLK — Traverse Tribrach Adapter



TRI-MAX® TRIPODS

The Tri-Max® is the only surveying-grade tripod with certified accuracy – highly recommended for all servo-driven and robotic total stations, 3-D laser scanners or construction lasers.

Tri-Max® Wood Instrument Tripod

Hardwood Tri-Max® precision instrument tripod



FEATURES & BENEFITS

- ▶ The tri-max wood tripod features the exact same revolutionary design and construction quality as the fiberglass Tri-Max tripod (90553) with improved stability and measurement accuracy from the hardwood legs
- ▶ Brass hinge bushings for extra stability
- ▶ High-quality hardwood material
- ▶ Complies with ISO 12858-2-H standards
- ▶ New foot equipped with replaceable point
- ▶ Foot designed to allow a solid placement in any terrain and improved stability
- ▶ Rubberized Carrying Handle included
- ▶ Head Cap included
- ▶ Shoulder Strap and Leg Slip Strap included, 38mm wide
- ▶ Individual SN for ID and Inventory control
- ▶ Quality cast aluminum housings, powder painted black
- ▶ Oversized, 165 mm diameter flat round-head plate
- ▶ Length Extended: 182 cm
- ▶ Length Collapsed: 114 cm
- ▶ Weight: 8.84kg



- ▶ Retainer Strap (PN 91715) prevents leg kick out on slick surface

Note: Retainer Strap sold separately.

91715 — Retainer Strap

Part No.	LOCK TYPE	LEGS	WEIGHS	EXTENSION	HEAD	HARDWARE
90550-WD	Quick Clamp	Wood	19.00 lb (8.64 kg)	71 in (1.8 m)	Flat	Black
90551-WD	Screw Clamp	Wood	19.00 lb (8.64 kg)	71 in (1.8 m)	Flat	Black
90553-WD	Dual Clamp	Wood	19.00 lb (8.64 kg)	71 in (1.8 m)	Flat	Black

Fiberglass Tri-Max Tripods

Certified accurate premier instrument tripod



FEATURES & BENEFITS

- ▶ The revolutionary design of this tripod series means this tripod will meet ISO standard (12858-2-H) right out of the box, and after years of field use
- ▶ The shape and size of the foot are designed to allow for a solid placement on any terrain
- ▶ Features a round head with large center hole to facilitate an easy set-up over a point
- ▶ Long lasting fiberglass
- ▶ The large 'footbed' is there to facilitate solid planting for stability
- ▶ Features positive locking systems
- ▶ A retaining system—which prevents leg kick out and accidental falls on slick surfaces—is stored on the inside of the leg and can be left in place when the tripod is not in use
- ▶ The foot is equipped with a replaceable point and a retention loop for use with a safety strap
- ▶ Tri-Max tripods can handle equipment up to 30 kg (65 lb)
- ▶ Collapsed: 113 cm (44.5 in) except 90560: 54 in (1.37 m)

APPLICATIONS

- ▶ Robotics
- ▶ Scanning
- ▶ Leveling

Part No.	LOCK TYPE	LEGS	WEIGHS	EXTENSION	HEAD	HARDWARE
90550	Quick Clamp	Fiberglass	17.00 lb (7.70 kg)	71 in (1.8 m)	Flat	Black
90551	Screw Clamp	Fiberglass	17.00 lb (7.70 kg)	71 in (1.8 m)	Flat	Black
90553	Dual Clamp	Fiberglass	17.00 lb (7.70 kg)	71 in (1.8 m)	Flat	Black
90560	Dual Clamp	Fiberglass	20.00 lb (9.00 kg)	91 in (2.3 m)	Flat	Black

Universal Tri-Max Elevator Tripod

A gear box controls the lift and descent so the center column cannot free fall



90557-050

FEATURES & BENEFITS

- ▶ SECO's Universal Tri-Max® Elevator Tripod features a working height range of 4.10 ft (1.20 m) collapsed to 8.60 ft (2.62 m) extended with the center column at full height
- ▶ Center column independently lifts 1 meter (90558-050)
- ▶ A gear box controls lift and descent so the center column cannot free fall
- ▶ The 5/8 x 11 mounting head is removable and adjustable in azimuth direction
- ▶ Fiberglass Legs

- ▶ Additional 1 meter section may be added for a total recommended height of 10 ft (3 m) for instruments under 15 lb (6.80 kg)
- ▶ Sections can move up or down
- ▶ Machined-aluminum elevator column and fiberglass legs makes for a robust and easy-to-use laser instrument tripod
- ▶ Stable for instruments up to 25 lb (11.33 kg) under most conditions
- ▶ Weighs 29.00 lb (13.20 kg)
- ▶ Collapsed length 53 in

APPLICATIONS

- ▶ Robotics
- ▶ Scanning
- ▶ Leveling

- 90558 — Universal Tri-Max Elevator Tripod
- 90558-050 — 1 Meter Extension for Universal Tri-Max Elevator Tripod
- 90557-050 — Tri-Max Wheel Kit
- 90558-052 — Adaptor Plate, 3/8-16



Short Tri-Max

Standard Tri-Max quality in a smaller size



FEATURES & BENEFITS

- ▶ The Tri-Max® Short Quick Clamp Tripod features the exact same design and construction as the full-size (90550) Tri-Max but it is more portable

- ▶ Extends to 5.67 ft (1.73 m)
- ▶ Collapses to 3.44 ft (1.05 m)
- ▶ Highly recommended for all servo-driven and robotic total stations and 3-D laser scanners
- ▶ Fiberglass legs
- ▶ Weighs 15.40 lb (7.00 kg)

APPLICATIONS

- ▶ Robotics
- ▶ Scanning
- ▶ Leveling

- 90550-S — Short Fiberglass Tri-Max Tripod

Premier Fiberglass Tripod

Improved quality and stability for more accurate measurements



FEATURES & BENEFITS

- ▶ 6-5/8 inch (16.83 cm) flat round head with large center hole
- ▶ 2-5/8 inch, 6.67 cm) to facilitate an easy set-up over a point
- ▶ Foot is equipped with a replaceable point made of hardened steel

- ▶ Standard 5/8 x 11 threaded brass instrument stud
- ▶ Snap cap to protect tripod head
- ▶ Extends to 70.75 inches (179 cm)
- ▶ Collapses to 43.75 inches (111 cm)
- ▶ Made in North America under strict quality controls

- ▶ Includes a comfortable shoulder strap for carrying over longer distances

APPLICATIONS

- ▶ Ideal for mounting theodolites, lasers, auto levels, or total stations

PART NO.	LOCKING	LEGS	EXTENDS	COLLAPSES	WEIGHS	COLOR	
90582	Dual Lock	Fiberglass	70.75 in (179 cm)	43.75 in (111 cm)	13.60 lb (6.16 kg)	Orange (shown)	

Extra-Tall Fiberglass Elevator Tripod

Locking leg stabilizers provide greater stability



FEATURES & BENEFITS

- ▶ Tripod has a fully-extended leg and center column height of 12.40 ft (3.80 m) and a collapsed height of 5.97 ft (1.82 m)
- ▶ Features an adjustable center column that gives you 3.7 ft (1.12 m) of lift
- ▶ Lockable leg stabilizer struts, dual clamps, screw clamp and

- quick clamp, along with dual metal and rubber leg points and handy leg strap create greater stability
- ▶ Detachable round head plate, with a 5/8 x 11 stud, gives your instrument a sturdy platform
- ▶ Column can hold 66 lb (30 kg) when collapsed, and 15.4 lb (7 kg) when elevating
- ▶ Legs and dowels are constructed of fiberglass

- for durability, strength and resistance to weathering
- ▶ Includes leg straps
- ▶ Will fit in tripod carrying bag 8153-10 (page 67)
- ▶ Weighs 33.10 lb (15.00 kg)

APPLICATIONS

- ▶ Use with lasers, scanners, machine control or other instruments

5321-17-ORG — Extra-Tall Fiberglass Elevator Tripod

Birch Wood / Fiberglass Hybrid Tripod

Improved kiln dried birch wood / fiberglass hybrid tripod models



FEATURES & BENEFITS

- ▶ Combination of hardwood legs with fiberglass dowels provides stability and weather resistance
- ▶ Large aluminum head and leg hinges provide stable mounting base

- ▶ Double banded extension legs and large positive locking quick clamp for extra stability
- ▶ Powder coated wear-resistant metal hardware
- ▶ Aluminum shoe with hardened steel replaceable shoe points

- ▶ Includes: plastic head cap for protection, heavy-duty poly-webbing shoulder strap for ease of carrying to the job site (not shown)

PART NO.	MATERIAL	EXTENDED	COLLAPSES	CLAMPING	HEAD	WEIGHT	COLOR	
5302-13-BLK	Wood / Fiberglass	69" (175.26 cm)	43" (109 cm)	Quick Clamp	Triangle	16.5 lb (7.48 kg)	Black	
5302-13-ORG	Wood / Fiberglass	69" (175.26 cm)	43" (109 cm)	Quick Clamp	Triangle	16.5 lb (7.48 kg)	Orange	
5402-13-BLK	Wood / Fiberglass	72" (183 cm)	43" (109 cm)	Twist Locks	Triangle	15.7 lb (7.14 kg)	Black	
5402-13-ORG	Wood / Fiberglass	72" (183 cm)	43" (109 cm)	Twist Locks	Triangle	15.7 lb (7.14 kg)	Orange	

Disclaimer: the full-view tripod is a composite photograph for illustrative purposes

Heavy-Duty Birch Wood Tripods

Improved kiln dried birch wood tripod models

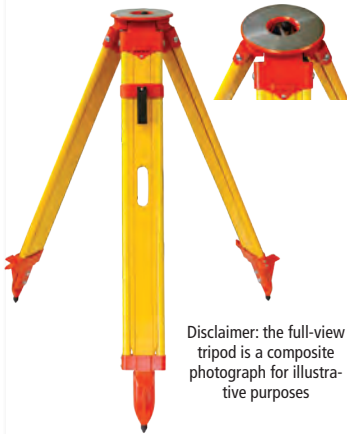

Disclaimer: the full-view tripod is a composite photograph for illustrative purposes

FEATURES & BENEFITS

- ▶ Made of high quality birch hardwood with wide-frame extension legs and 123mm (0.91") dowels
- ▶ Large 6.5" (165mm) aluminum head
- ▶ Twist locks with die cast leg bands for maximum locking
- ▶ Quick clamps, adjustable, for quick set ups
- ▶ Powder Coated metal fittings
- ▶ Aluminum shoe with hardened steel replaceable shoe points

- ▶ Instrument Fastener brass 5/8-11
- ▶ Includes heavy-duty poly-webbing shoulder strap for ease of carrying to the job site (not shown)

PART NO.	MATERIAL	EXTENDED	COLLAPSES	CLAMPING	HEAD	WEIGHT	COLOR
5220-13-BLK	Wood	68" (173 cm)	43" (109 cm)	Dual Locks	Round	16.5 lb (7.48 kg)	Black
5220-13-ORG	Wood	68" (173 cm)	43" (109 cm)	Dual Locks	Round	16.5 lb (7.48 kg)	Orange
5420-13-BLK	Wood	72" (183 cm)	43" (109 cm)	Twist Locks	Round	15.0 lb (6.82 kg)	Black
5420-13-ORG	Wood	72" (183 cm)	43" (109 cm)	Twist Locks	Round	15.0 lb (6.82 kg)	Orange

Aluminum Elevator Tripods

Locking leg stabilizers provide greater stability



FEATURES & BENEFITS

- ▶ Aluminum elevator tripods have smooth operating adjustable center columns
- ▶ Black hardware
- ▶ Tough kick-in cleats and points
- ▶ Features a built-in circular vial in the instrument head and safety chains on the legs to prevent slipping on hard surfaces
- ▶ Will fit in tripod carrying bag 8154-12 (page 67)

APPLICATIONS

- ▶ Ideal for lasers, scanners, machine control or other instruments

PART NO.	LOCK TYPE	HEAD	EXTENDS	COLLAPSES	WEIGHS
5321-16-BLK	Quick Clamp	Elevator / Round	7.60 ft (2.3 m)	4.26 ft (1.26 m)	16.30 lb (7.39 kg)

Square Leg Aluminum Tripods

Heavy-duty aluminum square leg tripods offer stability and accuracy



FEATURES & BENEFITS

- ▶ Equipped with square outer dowels for a more secure lock
- ▶ These tripods are equipped with a 5/8 x 11 threaded adapter for convenient mounting of instruments
- ▶ They're built to last—with heavy construction throughout—and are designed to withstand rigorous field conditions

APPLICATIONS

- ▶ Ideal for mounting theodolites, lasers, auto levels, or total stations

PART NO.	LOCK TYPE	LEGS	WEIGHS	EXTENSION	HEAD	HARDWARE
5301-31-BLK	Quick Clamp	Aluminum (Square)	9.70 lb (4.40 kg)	64 in (1.60 m)	Triangle / Flat	Black
5301-31-ORG	Quick Clamp	Aluminum (Square)	9.70 lb (4.40 kg)	64 in (1.60 m)	Triangle / Flat	Orange

Round Leg Aluminum Tripods

Sturdy and lightweight tripods for many applications



FEATURES & BENEFITS

- ▶ These tripods accommodate 5/8 x 11 instruments and are designed for all types of jobs
- ▶ Choices include: Flat or dome head, standard, elevator or mini tripod size

- ▶ The telescopic legs allow for setup at various heights and are available with orange or black hardware (on some models)

APPLICATIONS

- ▶ Ideal for mounting theodolites, lasers, auto levels, or total stations

PART NO.	LOCK TYPE	LEGS	WEIGHS	EXTENSION	HEAD	HARDWARE	
5301-21-ORG	Quick Clamp	Aluminum (Round)	9.35 lb (4.24 kg)	65 in (1.65 m)	Triangle / Flat	Orange	
5301-21-BLK	Quick Clamp	Aluminum (Round)	9.35 lb (4.24 kg)	65 in (1.65 m)	Triangle / Flat	Black	
5301-25-BLK	Quick Clamp	Aluminum (Round)	7.45 lb (3.38 kg)	63.5 in (1.60 m)	Triangle / Flat	Black	
5301-24-BLK	Quick Clamp	Aluminum (Round)	6.75 lb (3.06 kg)	27 in (68.65 cm)	Triangle / Flat	Black	
5311-21-ORG	Quick Clamp	Aluminum (Round)	7.60 lb (3.45 kg)	63.5 in (1.60 m)	Dome	Orange	
5401-21-BLK	Screw Clamp	Aluminum (Round)	8.13 lb (4 kg)	67 in (1.68 m)	Triangle / Flat	Black	
5401-24-BLK	Twist Lock	Aluminum (Round)	6.75 lb (3.06 kg)	27 in (68.65 cm)	Triangle / Flat	Black	

Tripod Dolly

Moves a tripod quickly to the next shot without breaking down the instrument



FEATURES & BENEFITS

- ▶ Tripod Dolly for all surveying tripods
- ▶ Easily maneuvered through doorways

- ▶ Folds for portability, 25.5" folded
- ▶ Convenient carrying handle
- ▶ Locking 5" diameter, hard rubber wheels; ball bearing casters with cable guards

- ▶ Adjustable Velcro straps to keep tripod secure
- ▶ Load capacity 132 lbs
- ▶ Weight 17 lbs

Note: Tripod not included with dolly.



5610-15 — Tripod Dolly

Cross Reference Table

Bags and Cases For Instrument Tripods

BAGS	PAGE NUMBER	TRIPODS WILL FIT	
8150-20-ORG	Pg. 67	Every Tripod Except for; 90558, 90560, 5321-17-ORG	
8153-10-ORG	Pg. 67	5321-17-ORG and 5115-00	
8154-00-ORG	Pg. 67	5119-00	
8154-10-ORG	Pg. 67	5300-11 and 5300-12	
8154-11-ORG	Pg. 67	Every Tripod Except for; 90558, 90560, 5321-17-ORG	
8154-12-ORG	Pg. 67	5119-10	

Instrument Tripod Accessories

- ▶ Designed to provide the extra stability required when working indoors on concrete and other hard surfaces
- ▶ Made of heavy-duty aluminum
- ▶ Measures 35 x 35 x 35 inches (889 x 889 x 889 mm)
- ▶ Collapses for compact storage
- ▶ Rubber o-ring fits over the foot of the tripod for extra stability
- ▶ Weighs 3.00 lb (1.36 kg)

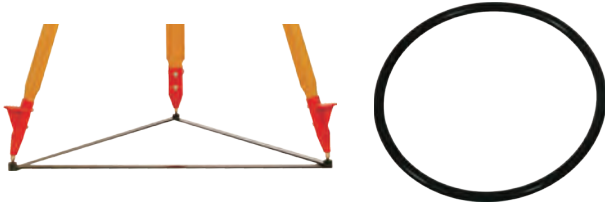

5610-00 — Tripod Stabilizer

- ▶ This Stabilizer helps prevent tripod legs from slipping when used on hard, slick surfaces.
- ▶ Lightweight and portable
- ▶ Collapses to 26 3/8" (67 cm)
- ▶ Opens to a three point star with 26 1/2" (67 cm) legs
- ▶ Two 0.315" (8 mm) hole in each leg, one at 35 cm from center and one at 65 cm.
- ▶ Anodized aluminum legs
- ▶ O-rings to hold tripod foot in place
- ▶ Center opening 1 7/8" (45 mm)
- ▶ Weight 1.05 lbs (0.48 kg)

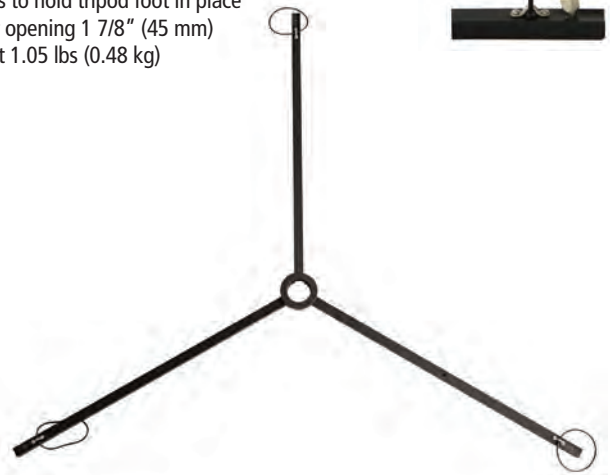

5610-01 — Tripod Stabilizer

- ▶ Lightweight and portable, keep your tripod level in all surface conditions
- ▶ Simple to use
- ▶ Features cleats to minimize slipping
- ▶ Attached bungee cables enable easy carrying, hanging or placement
- ▶ Sold in packs of three
- ▶ Each weighs 0.29 lb (0.12 kg)



5610-11 — Sta-Level Feet Tripod Stabilizer (w/ Rubber Pads)

- ▶ Provides non-slip support for tripods
- ▶ Works on all ferrous metal surfaces
- ▶ Includes three 5-inch round ceramic magnets
- ▶ Each magnet has a tripod point connection with a bungee strap
- ▶ Handle to remove magnet from surface included
- ▶ Each magnet has 210 pull pounds
- ▶ Kit bag is included



5610-12 — Tripod Anchor Kit

Leveling Rod Accessories

- ▶ Use with aluminum leveling rods
- ▶ Weighs 0.50 lb (0.23 kg)



7321-050 — Leveling Rod Vial

- ▶ These replacement rod button kits fit on SECO aluminum leveling rods



70014-6 — Round 17 mm Button
70014-7 — Round 13 mm Button w/ Ring

- ▶ 6-inch long caliper for SVR/Oval rods and CMR ruler



91014 — 6-inch Caliper for SVR/Oval Rods and CMR Ruler

- ▶ Adapt the thread size to 5/8 x 11 for mounting prisms on the LR's female adapter
- ▶ Weighs 0.20 lb (0.09 kg)



91133 — 5/8 x 11 Double Male Prism Adapter

- ▶ USL/SVR Hook



91275 — USL/SVR Hook

- ▶ Swiss-Style Prism Adapter



6601-01 — Swiss-Style Prism Adapter 1/4 x 20 Threads

- ▶ Snap-Tite® SVR Rod Level



91255 — Snap-Tite SVR Rod Level

- ▶ Snap-Tite CR Rod Level



91535 — Snap-Tite CR Rod Level

- ▶ The Leveling Plates (or Turtles as they are commonly known) are cast heavy steel and red powder painted for durability
- ▶ Other quality features include chrome plating on the dome, carrying handle and ground points
- ▶ Use to improve the accuracy of level runs in soft terrain
- ▶ Diameter 5.51 in (14 cm)
- ▶ Diameter of half ball 1.81 in (3 cm)
- ▶ Height of half ball 0.79 in (2 cm)
- ▶ Height of foot to top half ball 2.60 in (6.6 cm)
- ▶ Weighs 4.41 lb (2.00 kg)



7304-01 — Leveling Plate (Turtle)

- ▶ 5/8 x 11 Prism Mounting Adapter Kit



91258 — 5/8 x 11 Prism Mounting Adapter Kit

- ▶ This bipod features a special head that will hold a rectangular rod
- ▶ The head will fit rods with widths between 1.57 inches (39.9 mm) and 2.56 inches (65.0 mm)



5217-21-FOR — Leveling Rod Thumb Release Bipod

- ▶ This bipod features a special head that will hold a rectangular rod
- ▶ The head will fit rods with widths between 2.95 inches (74.9 mm) and 3.8 inches (96.5 mm)
- ▶ Depth: 1.75 inches (44.4 mm)



5217-20-FLY — Invar Rod Thumb Release Bipod

SVR Brackets for Laser Receivers

Easily attaches to SVR rods



FEATURES & BENEFITS

- ▶ Brackets are needed to attach laser sensors to the SVR rod

- ▶ Top or side brackets are available for all popular laser receiver models

APPLICATIONS

- ▶ Use with an SVR rod to mount your laser receiver

PART NO.	MOUNT TYPE	DESIGNED FOR	
91100	Top	Universal	
91162	Top	Storm® HL700/750/450	
91163	Side	Storm HL700/750/450	

'E' Pattern Builder's Rods

Dual-sided lightweight rod









FEATURES & BENEFITS

- ▶ Features a standard 'E' pattern
- ▶ Lightweight aluminum sections are in contrasting white, red and black colors and have round spring-loaded locking buttons

- ▶ Graduations are cm on the front
- ▶ Back Side Scale is either a Height Scale or a Standard Scale
- ▶ Includes a level vial and case

APPLICATIONS

- ▶ Grading
- ▶ Masonry
- ▶ Site work
- ▶ Forms
- ▶ Landscaping
- ▶ Foundations
- ▶ Sewers
- ▶ Slab work

PART NO.	LENGTH	GRADS	BACK SIDE SCALE	WEIGHS	
7341-41	4 m	cm	Height Scale MM	3.10 lb (1.40 kg)	
7341-45	4 m	mm	Standard Scale MM	3.10 lb (1.40 kg)	
7341-51	5 m	cm / mm	Standard Scale MM	3.80 lb (1.73 kg)	
7341-52	5 m	cm / inches	Standard Scale MM	3.80 lb (1.73 kg)	
7341-55	5 m	cm / mm	Height Scale MM	3.80 lb (1.73 kg)	
7341-56	5 m	UK cm / mm	Standard Scale MM	3.80 lb (1.73 kg)	

Aluminum Builder's Rods

Light and durable anodized leveling rods



FEATURES & BENEFITS







- ▶ These aluminum leveling rods are made of a light and durable alloy
- ▶ The telescopic sections are anodized and silk-screened with moisture-resistant ink

- ▶ Each rod section uses sturdy polycarbonate buttons that lock each section when extended; the height gauge is on the back side
- ▶ Each rod includes a special level and protective bag

APPLICATIONS

- ▶ Grading
- ▶ Masonry
- ▶ Site work
- ▶ Forms
- ▶ Landscaping
- ▶ Foundations
- ▶ Sewers
- ▶ Slab work

*Replacement buttons PN: 70014-6 or 70014-7 (see page 48)

PART NO.	SECTIONS	LENGTH	GRADS	WEIGHS	
7321-30	3	9 ft, 9.5 in	8ths	2.40 lb (1.10 kg)	
7301-30	3	9.8 ft	10ths	2.40 lb (1.10 kg)	
7321-40	4	13 ft, 1.38 in	8ths	3.10 lb (1.40 kg)	
7301-40	4	13.12 ft	10ths	3.10 lb (1.40 kg)	
7341-40	4	4 m	5 mm	3.10 lb (1.40 kg)	
7321-50	5	16 ft, 4.75 in	8ths	3.50 lb (1.60 kg)	
7301-50	5	16.4 ft	10ths	3.50 lb (1.60 kg)	

Surveyor's Series (SVR) Leveling Rods

Waterproof and wear-resistant

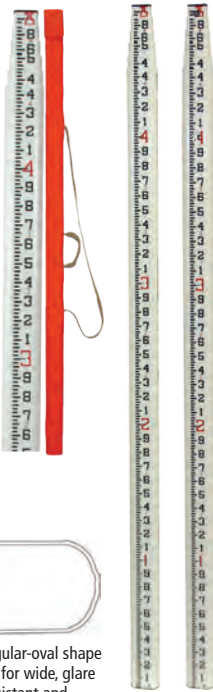

Rectangular-oval shape allows for wide, glare resistant and wear-resistant scales.

FEATURES & BENEFITS

- ▶ Features a new shorter collapsed length (58.5 inches on 25 ft versions) and a lighter weight
- ▶ Constructed of strong, rigid fiberglass with reinforcing ribs for added stability
- ▶ Water-resistant and non-conductive
- ▶ A tight locking mechanism features round buttons that resist jamming from sand and dirt
- ▶ Includes a 1/4 x 20 female adapter in top section

APPLICATIONS

- ▶ Grading
- ▶ Masonry
- ▶ Site work
- ▶ Forms
- ▶ Landscaping
- ▶ Foundations
- ▶ Sewers
- ▶ Slab work

Includes carrying case. Order 91411 for replacement carrying case – see page 68

PART NO.	HEIGHT SCALE	LENGTH	GRADS	BACK SCALE	WEIGHS	
98010	Height Scale	25 ft (7.6 m)	10ths	No	6.00 lb (2.72 kg)	
98011	Height Scale	25 ft (7.6 m)	8ths	No	6.00 lb (2.72 kg)	
98012	Height Scale	25 ft (7.6 m)	0.5 cm metric	No	6.00 lb (2.72 kg)	
98013	Height Scale	25 ft (7.6 m)	'E' metric	Yes	6.00 lb (2.72 kg)	
98014	Height Scale	25 ft (7.6 m)	Philly metric	No	6.00 lb (2.72 kg)	
98015	Dual Scale	25 ft (7.6 m)	8ths / 10ths	No	6.00 lb (2.72 kg)	
98016	Dual Scale	25 ft (7.6 m)	10ths / Philly Metric	No	6.00 lb (2.72 kg)	
98017	Dual Scale	25 ft (7.6 m)	10ths / 10ths	No	6.00 lb (2.72 kg)	
98020	Height Scale	17 ft (5.18 m)	10ths	No	5.00 lb (2.27 kg)	
98021	Height Scale	17 ft (5.18 m)	8ths	No	5.00 lb (2.27 kg)	
98023	Height Scale	17 ft (5.18 m)	'E' metric	Yes	5.00 lb (2.27 kg)	
98024	Height Scale	17 ft (5.18 m)	Philly metric	No	5.00 lb (2.27 kg)	
98025	Dual Scale	17 ft (5.18 m)	8ths / 10ths	No	5.00 lb (2.27 kg)	
98026	Dual Scale	17 ft (5.18 m)	10ths / Philly metric	No	5.00 lb (2.27 kg)	

Standard/Pro Series (LR) Leveling Rods

Round rod is wind resistant

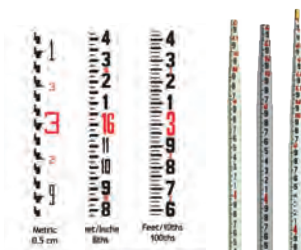

Round design makes the LR Series rods a good choice for certain applications like in areas of high wind.

FEATURES & BENEFITS

- ▶ The LR Series leveling rods are round and easy to handle
- ▶ The LR-STD is available in a 25 ft model in 10ths, inches, and 0.5 cm metric scales
- ▶ The LR-PRO is larger in diameter so sturdier and easier to read
- ▶ The LR-PRO is available in 25 ft, 35 ft and 45 ft lengths in feet/10ths/100ths

APPLICATIONS

- ▶ Grading
- ▶ Masonry
- ▶ Site work
- ▶ Forms
- ▶ Landscaping
- ▶ Foundations
- ▶ Sewers
- ▶ Slab work

Includes carrying case. Order 91402 for replacement carrying case – see page 68

PART NO.	LENGTH	OUTSIDE DIAMETER	GRADS	WEIGHS	
90004	LR-STD 25 ft	1-5/8 inch	10ths	5.00 lb (2.26 kg)	
90009	LR-STD 25 ft	1-5/8 inch	8ths	5.00 lb (2.26 kg)	
90014	LR-STD 7.6 m	1-5/8 inch	Metric	5.00 lb (2.26 kg)	
90022	LR-PRO 25 ft	2 inch	10ths	7.00 lb (3.17 kg)	
90024	LR-PRO 35 ft	2-3/16 inch	10ths	9.00 lb (4.08 kg)	
90026	LR-PRO 45 ft	2-3/16 inch	10ths	10.00 lb (4.53 kg)	

Rectangular Series (CR) Leveling Rods

Rounded back corners for better gripping

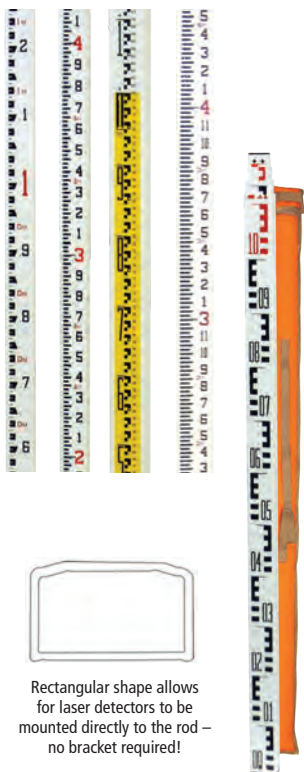

Rectangular shape allows for laser detectors to be mounted directly to the rod – no bracket required!

FEATURES & BENEFITS

- ▶ Features a rectangular shape with rounded back corners for better gripping
- ▶ Scale width is graduated to fill the entire face of the rod and measuring scale on the back side that allows for overall height readings

- ▶ For laser detector mounting with no special brackets required
- ▶ Made with strong fiberglass which is waterproof, corrosion-resistant and non-conductive
- ▶ Features 1/4 x 20 female adapter in the top section

APPLICATIONS

- ▶ Grading
- ▶ Masonry
- ▶ Site work
- ▶ Forms
- ▶ Landscaping
- ▶ Foundations
- ▶ Sewers
- ▶ Slab work

Includes carrying case. Order 91410 for 8 ft or 91411 for 13 - 20 ft replacement carrying case – see page 68

PART NO.	LENGTH	GRADS	BACK SIDE SCALE	WEIGHS	
92001	8 ft	10ths	No	3.00 lb (1.36 kg)	
92002	8 ft	8ths	No	3.00 lb (1.36 kg)	
92021	13 ft	10ths	No	5.00 lb (2.26 kg)	
92022	13 ft	8ths	No	5.00 lb (2.26 kg)	
92041	16 ft	10ths	No	6.00 lb (2.72 kg)	
92042	16 ft	8ths	No	6.00 lb (2.72 kg)	
92031	20 ft	10ths	No	7.00 lb (3.17 kg)	
92032	20 ft	8ths	No	7.00 lb (3.17 kg)	
92026	4.0 m	'E' metric	Yes	5.00 lb (2.26 kg)	
92027	4.0 m	0.5 cm metric	No	5.00 lb (2.26 kg)	
92046	5.0 m	'E' metric	Yes	6.00 lb (2.72 kg)	
92047	5.0 m	0.5 cm metric	No	6.00 lb (2.72 kg)	
92048	5.0 m	British 'E' metric	Yes	6.00 lb (2.72 kg)	
92043	5.0 m	Philly metric	No	6.00 lb (2.72 kg)	

SK Leveling Rods



FEATURES & BENEFITS

- ▶ Non-conductive lightweight fiberglass leveling rods
- ▶ Waterproof and corrosion-proof even against seawater
- ▶ Unique patented oval shape permits equal size graduations full-length, prevents rod from rolling and is easier to hold

- ▶ Numerals and graduations are epoxy-protected for maximum wear-resistance and sized for maximum readability.
- ▶ The Level Rod Sections are cushioned with glides to prevent wear.
- ▶ Height measuring gauge on the back side.

- ▶ 5/8 x 11 female thread for prism attachment
- ▶ Includes carrying bag

7400-10 — SK Leveling Rod Feet / in 10ths

7400-20 — SK Leveling Rod Feet / in 8ths

7400-30 — SK Leveling Rod Metric (E-Type)

Heavy-Duty Pocket Tape

Light weight measuring tools for all situations



FEATURES & BENEFITS

- ▶ Rubberized black and high visibility yellow case
- ▶ Positive thumb lock and release action

- ▶ Lengths vary from 12 ft to 33 ft
- ▶ Tape made from epoxy paint coated steel

Applications

- ▶ General construction

PART NO.	LENGTH	WIDTH	GRADS	
4769-00	25 ft	1 inch (32 mm)	10ths	
4769-01	25 ft	1 inch (32 mm)	10ths / Metric	
4769-02	25 ft	1 inch (32 mm)	10ths / 8ths	
4769-03	33 ft	1 inch (32 mm)	10ths	
4769-04	33 ft	1 inch (32 mm)	10ths / 8ths	
4769-06	33 ft (10 m)	1 inch (32 mm)	10ths / Metric	
4769-14	5 m	3/4 inch (19 mm)	m/cm/mm	

Coated Fiberglass and Steel Measuring Tapes

Great in all kinds of weather conditions



FEATURES & BENEFITS

- ▶ These coated tapes are designed to be used in the field for many years
- ▶ Single sided tape

- ▶ Choose between PVC-coated fiberglass or nylon-coated steel tape
- ▶ Features a hook end and fast-winding crank

APPLICATIONS

- ▶ General construction

PART NO.	TYPE	LENGTH	GRADS	
3003-06	PVC-Coated Fiberglass	100 ft	10ths	
3003-07	PVC-Coated Fiberglass	200 ft	10ths	
3003-10	PVC-Coated Fiberglass	30 m	m/cm/mm	
3006-06	Nylon-Coated Steel	100 ft	10ths	
3006-07	Nylon-Coated Steel	200 ft	10ths	
3006-10	Nylon-Coated Steel	30 m	m/cm/mm	
3006-11	Nylon-Coated Steel	60 m	m/cm/mm	
3006-18	Nylon-Coated Steel	200 ft/60 m	10ths / Metric (Dual Grad)	

Rhino Ruler® Engineer's Folding Ruler

Waterproof fiberglass outlasts wood rulers



FEATURES & BENEFITS

- ▶ Waterproof fiberglass construction prevents common problems that occur with wood rulers such as fading, splintering, and chipping

- ▶ Engraved graduations resist weather and scratches
- ▶ Easy-to-fold locking joints are tighter than traditional folding rulers made of wood allowing for a more accurate measurement along the ruler's length

APPLICATIONS

- ▶ General construction

4770-00 — Rhino Ruler Waterproof Fiberglass Engineer's Folding Ruler - 10ths / 8ths
 4770-01 — Rhino Ruler Waterproof Fiberglass Engineer's Folding Ruler - 10ths / Metric



CMR Series Measuring Rulers with Cases

Designed for one-person measuring



FEATURES & BENEFITS

- ▶ A versatile tool for fast, accurate, one-person measuring, the CMR Series is the tool for measuring heights, clearances and horizontal distances up to fifty feet

- ▶ The rod is equipped with a female 1/4 x 20 adapter in the top section
- ▶ Made of rugged, non-conductive fiberglass and includes a carrying case and calliper tip

- ▶ Carrying cases are made from the highest quality 1000-denier nylon

PART NO.	LENGTH	WEIGHT	OD	REPLACEMENT CARRY CASE	OD CASE MEASUREMENTS	
90180	25 ft (7.6 m)	5.00 lb (2.27 kg)	1-13/16 inch	91415	3.5 x 65 in (8.89 x 165.1 cm)	
90181	36 ft (11 m)	9.00 lb (4.08 kg)	2-7/32 inch	91416	4.5 x 68 in (11.43 x 172.72 cm)	
90182	50 ft (15.2 m)	12.00 lb (5.44 kg)	2-13/32 inch	91417	4.5 x 76 in (11.43 x 193.04 cm)	

SubSurface® Handheld Magnetic Locators

Built by the team with the most experience in the industry



FEATURES & BENEFITS

- ▶ Both models come with an industry exclusive 7 year warranty
- ▶ Choose the standard model or the LCD meter model
- ▶ The ML-1M has visual indication in addition to audio
- ▶ Tube-through construction ensures strength and durability

- ▶ from the bottom tip to the handle
- ▶ Overall length: 38.75 in (98.4 cm)
- ▶ The system comes with a padded carrying bag and four alkaline 9-volt batteries — two to use and two spares
- ▶ Waterproof from bottom tip to LCD box
- ▶ Weighs 2.00 lb (0.91 kg)

APPLICATIONS

- ▶ Perfect for locating survey corner markers, PK and Mag Nails, valve and covers, steel and iron pipes, well casings, steel tanks, lost tools or even downed and buried fence lines

Hard-shell case is impact resistant ABS plastic construction (ML-1-050, sold separately)

- ML-1 — SubSurface Handheld Magnetic Locators Standard Model
- ML-1M — SubSurface Handheld Magnetic Locators With LCD Meter
- ML-1-050 — Hard Shell Case for Locators

Gopher Pole Wire Installation Tool

Installing wires across ceiling spans is a lot easier with this unique fiberglass pole



FEATURES & BENEFITS

- ▶ With its long, adjustable span of up to 22 feet, the Gopher Pole makes wiring easy in hard-to-reach areas such as suspended ceilings, sub-ooors, crawl spaces and attics
- ▶ Ideal for pushing/pulling wire over long spans and acoustic ceiling tiles
- ▶ Telescopes from 4 to 22 feet (1.22 to 6.70 meters) in seconds

- ▶ Features a positive-locking system that won't accidentally collapse
- ▶ Features a strong but malleable metal tip that allows for easy shaping of the hook
- ▶ Sturdy and lightweight with no loose parts; constructed of durable non-conductive fiberglass
- ▶ Includes a carrying case

APPLICATIONS

- ▶ Utility Companies
- ▶ Electrical Contractors
- ▶ Electrical Supply Distributors
- ▶ Communications
- ▶ Data Network Solutions
- ▶ Commercial And Industrial Lighting
- ▶ Security Equipment Firms
- ▶ General Interior Construction



- 90520 — Gopher Pole Wire Installation Tool
- 91415 — Carrying Case

Stream Gauges

Allows you to instantly see water levels

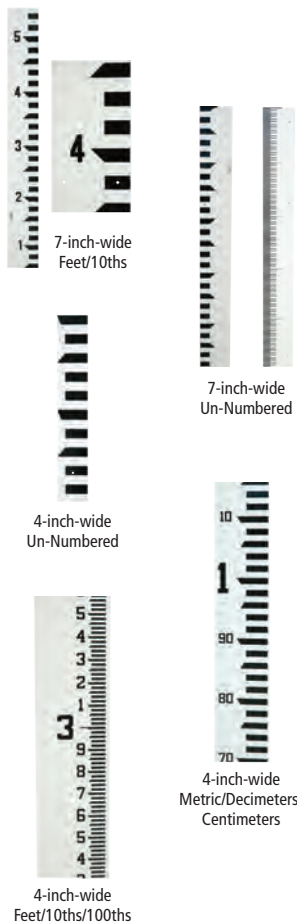

FEATURES & BENEFITS

- ▶ Stream Gauges allow you to instantly see water levels
- ▶ Fiberglass stream gauges are the best permanent marker in a variety of applications and environments
- ▶ Sturdy fiberglass assures a long life, it does not rot, rust or corrode
- ▶ Stream gauges are provided in separate units that can be used separately or combined for convenient measuring
- ▶ Easy to read at long distances, gauges are protected with a non-glare coating and are easy to mount

- ▶ Stainless steel fasteners are provided which will attach to most surfaces including metal, masonry, wood, and many other surface types
- ▶ 1/8 inch thick and the pre-drilled holes for mounting have a diameter of 1/4 inch
- ▶ Gauges may be ordered in successive increments to form ranges and elevations
- ▶ Number plates (sold separately) may be used to customize elevations for a particular application

APPLICATIONS

- ▶ Monitoring the water level of rivers, creeks, streams, bays etc.

7-inch Stream Gauges feature 2-1/4 inch (5.72 cm) tall numbers
 4-inch Stream Gauges features 1-1/4-inch (3.175 cm) tall numbers
 Use unnumbered gauges for height beyond 15.5 ft, 16 ft, or 3.66 m as needed

PART NO.	DESCRIPTION	LENGTH	WIDTH	GRADS	WEIGHS	
99000	Un-Numbered	4 ft	4 inch (10.2 cm)	feet / 10ths / 100ths	2.00 lb (0.91 kg)	
99001	4 ft	0 - 4 ft	4 inch (10.2 cm)	feet / 10ths / 100ths	2.00 lb (0.91 kg)	
99002	4 ft	4 - 8 ft	4 inch (10.2 cm)	feet / 10ths / 100ths	2.00 lb (0.91 kg)	
99003	4 ft	8 - 12 ft	4 inch (10.2 cm)	feet / 10ths / 100ths	2.00 lb (0.91 kg)	
99004	4 ft	12 - 16 ft	4 inch (10.2 cm)	feet / 10ths / 100ths	2.00 lb (0.91 kg)	
99023	Un-Numbered	4 ft	4 inch (10.2 cm)	feet / 10ths	2.00 lb (0.91 kg)	
99051	1.22 m	0 - 1.22 m	10.2 cm (4 inch)	m / dm / cm	2.00 lb (0.91 kg)	
99052	1.22 m	1.22 - 2.44 m	10.2 cm (4 inch)	m / dm / cm	2.00 lb (0.91 kg)	
99053	1.22 m	2.44 - 3.66 m	10.2 cm (4 inch)	m / dm / cm	2.00 lb (0.91 kg)	
99071	Un-Numbered	5 ft	7 inch (17.78 cm)	feet / 10ths	4.00 lb (1.81 kg)	
99072	Un-Numbered	5 ft	7 inch (17.78 cm)	feet / 10ths / 100ths	4.00 lb (1.81 kg)	
99079	5 ft	0.5 - 5.5 ft	7 inch (17.78 cm)	feet / 10ths	4.00 lb (1.81 kg)	
99080	5 ft	5.5 ft - 10.5 ft	7 inch (17.78 cm)	feet / 10ths	4.00 lb (1.81 kg)	
99081	5 ft	10.5 - 15.5 ft	7 inch (17.78 cm)	feet / 10ths	4.00 lb (1.81 kg)	



Mounting Hardware For Stream Gauges

Included with purchase of any Stream Gauge



FEATURES & BENEFITS

- ▶ Includes 7 sets of stainless steel screws and anchors

- ▶ Contains 14 each of screws and anchors packaged in packs of four

APPLICATIONS

- ▶ Monitoring the water level of rivers, creeks, streams, bays etc.

99043 — Mounting Hardware for Stream Gauges

**Stream Gauges
Plate Numbers**

Sturdy fiberglass assures a long life, will not rust or corrode

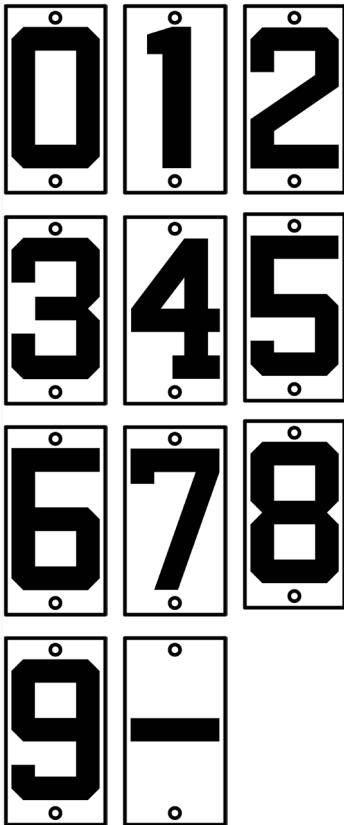

FEATURES & BENEFITS

- ▶ Number plates may be used to customize elevations for a particular application

- ▶ All stream gauges are 1/8-inch thick and the pre-drilled holes for mounting have a diameter of 1/4-inch

APPLICATIONS

- ▶ Monitoring the water level of rivers, creeks, streams, bays etc.

PART NO.	NUMBER PLATE	MEASURES	
99060	0 (zero)	2-1/4 x 4 inches	
99061	1 (one)	2-1/4 x 4 inches	
99062	2 (two)	2-1/4 x 4 inches	
99063	3 (three)	2-1/4 x 4 inches	
99064	4 (four)	2-1/4 x 4 inches	
99065	5 (five)	2-1/4 x 4 inches	
99066	6 (six)	2-1/4 x 4 inches	
99067	7 (seven)	2-1/4 x 4 inches	
99068	8 (eight)	2-1/4 x 4 inches	
99069	9 (nine)	2-1/4 x 4 inches	
99070	- (Minus)	2-1/4 x 4 inches	

Hand Levels

2 power stadia hand level with very sharp field of view and a stadia ratio 1:32



- ▶ Hand-finished for smooth and accurate operation
- ▶ Etched glass prisms and precision ground lenses
- ▶ There are no exposed screws to cause adjustment failure
- ▶ When taken apart for cleaning, they can be completely assembled and adjusted in the field
- ▶ The interiors are non-glare
- ▶ The exterior has a highly visible powder coating finish
- ▶ Five inches long when closed; seven inches long opened
- ▶ All hand levels include a leather carrying case with belt loop and snap flap, parts list and instructions
- ▶ Manufactured by Kuker-Ranken

4300-KR — 2-Power Stadia Hand Level



- ▶ Made from padded Nylon Cordura is perfect for your level
- ▶ Measures 6.5 x 2.62 inches (16.5 x 6.66 cm)
- ▶ Weighs 0.05 lb (0.02 kg)

Replacement case for hand levels

8030-00-CABLU — Hand Level Case

Magnetic Dampened Auto Level

Easy-to-use 24X and 32X auto-levels



FEATURES & BENEFITS

- ▶ The 32X auto level features a sturdy metal Japanese-style body with a magnetic dampened compensator
- ▶ Fits 5/8 x 11 flat or domed tripods
- ▶ The top cover plate is easily removed for adjustment
- ▶ Accurate to 1/16 inch per 100 feet (with good weather





- conditions)
- ▶ Includes carrying case
- ▶ Air dampened auto compensator
- ▶ Double-sided, continuous horizontal tangent drives
- ▶ Stadia lines for simple distance measurement
- ▶ Water resistant construction
- ▶ Convenient horizontal angle measurement

- ▶ Built in bubble mirror and optical sighting alignment
- ▶ Metal housing for increased durability

APPLICATIONS

- ▶ Two-person leveling across the job site
- ▶ Leveling forms and footers
- ▶ Checking elevation
- ▶ Measuring cut and fill



PART NO.	POWER/DAMPENING	TRIPOD	ROD		
4811-24	24X / Magnetic Dampened	No	None 		
4811-32	32X / Magnetic Dampened	No	None 		
AL24A	24X / Air Dampened	No	None 		
AL24M	24X / Magnetic Dampened	No	None 		
AL32A	32X / Air Dampened	No	None 		
SPECIFICATIONS	4811-24	4811-32	AL24A	AL24M	AL32A
Magnification	24X	32X	24X	24X	32X
Objective Diameter	36 mm	42 mm	30 mm	30 mm	36 mm
Field of View Angle	1° 20'	1° 20'	1° 20'	1° 20'	1° 20'
Shortest Focusing Distance	0.3 m	0.3 m	0.6 m	0.6 m	0.6 m
Stadia Constant	100	100	100	100	100
Additive Constant	0	0	0	0	0
Compensator Dampening	Magnetic	Magnetic	Air	Magnetic	Air
Compensator Range	±15'	±15'	±15'	±15'	±15'
Compensator Setting Accuracy	<0.5"	<0.5"	<0.5"	<0.5"	<0.3"
Double Run Leveling per 1 km	2 mm	1 mm	2 mm	2 mm	1 mm
Circular Vial Accuracy	8/2 mm	8/2 mm	8/2 mm	8/2 mm	8/2 mm
Horizontal Circle	1°	1°	1°	1°	1°
Base Plate	5/8 x 11	5/8 x 11	5/8 x 11	5/8 x 11	5/8 x 11
Color	Red	Red	Yellow	Yellow	Yellow
Weight	3.97 lb (1.80 kg)	3.97 lb (1.80 kg)	3.50 lb (1.60 kg)	3.50 lb (1.60 kg)	3.50 lb (1.60 kg)



Construction Theodolite

Full-featured digital theodolite for construction



DE-50
Optional eye piece sold
separately

FEATURES & BENEFITS

- ▶ Designed for general construction applications
- ▶ The Spectra Precision DET-2 digital electronic theodolite gives you accurate measurements in an affordable, versatile, easy to use platform
- ▶ Offers dual displays and controls for easy accessibility and operation, very large backlit LCD characters for easy reading (also, reduces eye strain and chance for errors), and a host of features and parameters normally found on much higher priced instruments
- ▶ Fast investment payback is the goal of the Spectra Precision DET-2
- ▶ With its 2-second accuracy (1- or 5-second selectable display readings) and vertical axis compensation, it can handle any construction job
- ▶ Operating costs are kept low with the included rechargeable battery pack and charger
- ▶ Able to be fully customized for your preferred operating style or job, with programmable settings for the horizontal angle resolution and beep, vertical degrees or %, automatic shutoff (to save battery life), and zenith angle

- ▶ A backup alkaline pack holding four standard AA batteries is also included
- ▶ Includes a built-in reticle illuminator that allows you to work inside buildings and other environments with little or no light, such as near dawn or dusk
- ▶ You can count on working in difficult conditions with an environmental rating of IP-54 making it water and dust-proof
- ▶ Comes equipped with a plumb bob, NiMH rechargeable battery pack and charger, alkaline battery pack, adjustment tools, rain hood, multi-language user guide, and hard-shell carrying case
- ▶ Accurate enough for any job, yet the display resolution can be tailored to any operator's preferences for fast readings
- ▶ Vertical axis compensation can be turned on or off depending on the operator or job
- ▶ Programmable settings for the horizontal angle resolution and beep, vertical degrees or percent are easy to configure
- ▶ The recharge kit reduces operating costs and downtime
- ▶ For Specifications see website

APPLICATIONS

- ▶ Establishing 90 degree reference lines
- ▶ Checking angles, alignment, and plumb
- ▶ Anchor bolt alignment
- ▶ Gravity flow pipe laser setup
- ▶ Steel column placement
- ▶ Alignment of forms, tilt-up walls, and curtain walls
- ▶ Basic grade work
- ▶ Short range leveling

DET-2 — Construction Theodolite
DE-50 — Diagonal Eye Piece



Batter Board Clamp

Accessories and components for rotating lasers



FEATURES & BENEFITS

- ▶ Attaches to boards with thicknesses up to 2.17 in (55 mm)
- ▶ Mounting plate with its 5/8 x 11 screw can easily be removed when connecting it to a laser or theodolite
- ▶ Nail hole ensures that a theodolite's axis is positioned exactly over the reference point

- ▶ Soft-touch locking knobs prove comfortable when using in cold and wet weather
- ▶ 3-point contact for secure, sturdy grip
- ▶ Quick release clamp for quick instrument attachment
- ▶ Weighs 2.43 lb (1.10 kg)

APPLICATIONS

- ▶ Perfect for a laser for vertical applications or Theodolites

4852-14 — Batter Board Clamp 

Lightning 2 Laser Detector

Lets you get to grade faster on a wide variety of job sites



FEATURES & BENEFITS

- ▶ The Lightning™ 2 has an easy-to-read dual LCD and LED displays
- ▶ Comes equipped with a snap-in rod clamp allowing for fast switching from rod-mounted to hand-held applications
- ▶ Tough IP67 waterproof housing protects the unit from dust, moisture, and accidental drops
- ▶ Loud 100 db speaker can be heard on noisy job sites
- ▶ With two on-grade sensitivities (fine and medium), the Lightning 2 lets you get to grade faster on a wide variety of job sites
- ▶ Weighs (with batteries) 0.65 lb (0.29 kg)
- ▶ Weighs (without batteries and rod clamp) 1.00 lb (0.45 kg)

APPLICATIONS

- ▶ Highly accurate distance measurement

ATI993600-09 — Lightning 2 Laser Detector – Yellow

Storm Laserometer Receiver

Highly-visible LED lights show red for off-grade and green for on-grade



FEATURES & BENEFITS

- ▶ Features a digital readout of elevation which provides a numeric display of ± 2 inches (± 5 cm)
- ▶ Accurate measurements can be made without moving the rod clamp, saving time and increasing productivity
- ▶ Waterproofed to IP67 standards
- ▶ The protective over-molding allows it to withstand a drop of 10 feet (3 meters) onto concrete
- ▶ The patented universal reversible clamp fits square and oval rods
- ▶ 5 inch (12.7 cm) reception height, allows quick acquisition of the laser beam
- ▶ A patented anti-strobe sensor prevents construction lights from giving faulty signals
- ▶ The high visible LEDs on the front show red for high and low and green for on-grade
- ▶ Fiberglass rod sold separately
- ▶ Weighs (with batteries) 0.85 lb (0.38 kg)
- ▶ Weighs (without batteries and rod clamp) 1.20 lb (0.54 kg)

APPLICATIONS

- ▶ Highly accurate distance measurement

ATI994000-09 — Storm Laserometer Receiver - Yellow

Twister Laser Receiver

Specifically designed for harsh, loud construction environments



FEATURES & BENEFITS

- ▶ Designed to receive reference elevation information from rotating laser levels
- ▶ Detector receives invisible laser beams as well as visible red beams
- ▶ Detector includes a Liquid Crystal Display (LCD) on the front and rear for easy indication of detector status and grade information
- ▶ Beeper emits an audible tone that indicates on-grade, high or low
- ▶ Specifically designed for use in harsh, loud construction environments
- ▶ Battery life is 70+ hours
- ▶ Beam window height is 2 inches
- ▶ Accuracy levels are user selectable to meet various job requirements
- ▶ Impact resistant housings, recessed windows, waterproof design, durable battery

- contacts, and a high volume beeper are incorporated into every detector
- ▶ General purpose clamp is designed to mount the detector on various grade rods and staffs
- ▶ Weighs 1.00 lb (0.45 kg) with batteries

APPLICATIONS

- ▶ Highly accurate distance measurement

ATI993640-09 — Twister Laser Receiver - Yellow

Bullseye 5+ Laser Receiver

Four selectable accuracies for each on-grade location



FEATURES & BENEFITS

- ▶ Angle compensation automatically calculates and corrects grade display for the angle of the dipper arm
- ▶ Check grade with the dipper arm extended or retracted up to 30°

- ▶ Plumb indication built in – for quick and accurate grade checking for excavators and backhoes
- ▶ Offset on-grade – for productive excavation
- ▶ Center On-grade – for grading operations – use on dozers,

- graders, scrapers, box blades
- ▶ Up to 8 channels of grade information plus directional out of beam indicators

APPLICATIONS

- ▶ Highly accurate distance measurement

PART NO.	POWER SOURCE	COLOR	
ATI991370-02	Alkaline	Red	
ATI991370-09	Alkaline	Yellow	
ATI991376-02	Rechargeable NIMH	Red	

Bullseye 3+ Laser Receiver

Use on dozers, graders, scrapers, and box blades



FEATURES & BENEFITS

- ▶ Adapts to grading and excavating machinery
- ▶ Easy to move from one machine to another
- ▶ 3 selectable accuracies - work from rough grading to final finishing

- ▶ Bright LED's with green on-grade
- ▶ 5 channels of grade information plus directional out of beam indicators

APPLICATIONS

- ▶ Highly accurate distance measurement

PART NO.	POWER SOURCE	COLOR	
ATI991340-02	Alkaline	Red	
ATI991340-09	Alkaline	Yellow	
ATI991346-02	Rechargeable NIMH	Red	

Bullseye Magnetic Mounts

Use with Bullseye Receivers



FEATURES & BENEFITS

- ▶ Both magnetic mount models can be used with all Bullseye receivers
- ▶ Two magnet banks combine for 900 pounds of holding force

- ▶ Easy to slide receiver up and down
- ▶ Easy removal is accomplished using a release lever
- ▶ Features a large vertical adjustment range for quicker laser set-ups



APPLICATIONS

- ▶ Highly accurate distance measurement

ATI991360-02 — Bullseye Magnetic Mount - For Backhoe and Excavator

ATI991364-02 — Bullseye Magnetic Mount - For Flat Back Dozer Blades

Bullseye Receiver Accessories

PART NO.	BULLSEYE RECEIVER ACCESSORIES	
ATI010972-50	Receiver cable, straight, 50 ft	
ATI010983	Machine power cable, lighter adapter, 2-8 ft	
ATI991604	Universal battery charger with wall plugs	

Rebar Bolts



FEATURES & BENEFITS

- ▶ Measures 3/4 x 9.9 inches (19.05 x 251.46 mm) long
- ▶ Includes a hex bolt used to hammer the bolt in to the surface

- ▶ Once installed, remove the hex bolt and install the 6601-Series adapter of your choice (see page 39)
- ▶ Weighs 1.25 lb (0.57 kg)

6602-03 — Rebar Bolt M8 Threads



Wall/Column Bracket for Lasers and Total Stations

Dual mounting options enable flexibility on the construction job site



FEATURES & BENEFITS

- ▶ SECO's 4852-17 is a dual-use bracket for lasers and total stations
- ▶ Mounts easily to columns (or corners) and flat walls
- ▶ The unique design allows quick and easy separation for dual usage

- ▶ 5/8 x 11 platform holds the instrument 5 inches from the wall/column surface
- ▶ A ratchet and strap secures the bracket to columns up to 20 inches (use Extension Strap #D12328 for larger columns, offering 37 to 69 inches of extra length)

- ▶ Multiple nail/screw holes enable wall mounting
- ▶ Features a powder coated steel frame
- ▶ Weighs 5.00 lb (2.30 kg)

APPLICATIONS

- ▶ For use with Lasers and Total Stations on large construction sites

4852-17 — Wall/Column Bracket for Lasers and Total Stations



Heavy Duty Instrument Column Clamp

Mounts to structural columns for stability and support for heavy instruments



FEATURES & BENEFITS

- ▶ SECO's Heavy Duty Column Clamp has a solid stable design and works with all 5/8 x 11 instruments
- ▶ The adjustable column rotates and moves vertically to orient the instrument when needed and features 12 inches (30.48 cm) of height adjustment
- ▶ Now with 0.39" holes in each corner for hard mounting with
 - 3/8 bolts (not supplied)
 - ▶ Centerline of the 5.8 x 11 stud to column measures 15 inches (38.1 cm)
 - ▶ Includes 20 inch standard 3/4 inch NPT Pipe with Heavy Duty sliding clamp
 - ▶ Constructed of structural aluminum for industrial applications and stainless steel hardware
 - ▶ Weight is 15 lbs (6.8 kg)

APPLICATIONS

- ▶ For use with Robotic Total Stations and scanners
- ▶ Ideal for mounting theodolites, lasers, etc.

Order 2" X10 ft ratchet strap kit 4852-18-050 as needed for different mounting options

4852-18 — Heavy Duty Instrument Column Clamp

Heavy-Duty Instrument Column Clamp

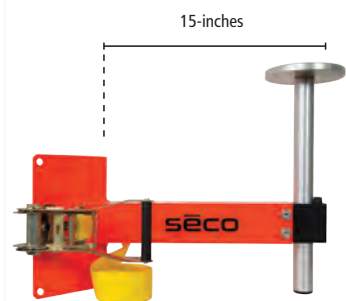

FEATURES & BENEFITS

- ▶ SECO's Heavy-Duty Column Clamp has a solid stable design and works with all 5/8 x 11 instruments
- ▶ The adjustable column rotates and moves vertically to orient the instrument when needed and features 12-inches (30.48 cm) of height adjustment
- ▶ Centerline of the 5/8 x 11 stud to column measures 15-inches (38.1-cm)
- ▶ Now with 0.39" holes in each corner for hard mounting with 3/8 bolts (not supplied)
- ▶ Includes a 2-inch (5.08 cm) by 10-ft (3.05-m) strap rated for a 2200 pound load and a heavy-duty ratchet to create a strong connection to both round and square columns
- ▶ Constructed of structural aluminum for industrial applications and stainless steel hardware
- ▶ Weighs 13.75 lb (6.24 kg)

APPLICATIONS

- ▶ For use with Robotic Total Stations and scanners
- ▶ Ideal for mounting theodolites, lasers, etc.

4852-16 — Heavy-Duty Column Clamp

Rotating Laser Column Clamp

Accessories and components for rotating lasers



FEATURES & BENEFITS

- ▶ Works with all 5/8 x 11 instruments
- ▶ Column rotates to orientate the instrument when needed and features 1 ft (30 cm) of height adjustment
- ▶ Center-line of the 5/8 x 11 stud to column measures 6.5 in (16.5 cm)
- ▶ Designed to fit both round and square columns
- ▶ A ratchet strap quickly tightens the column clamp into place to create a strong connection to columns with diameters up to 20 inches (0.5 m)
- ▶ Made of aluminum and stainless steel
- ▶ An Extension Strap is also available (D12328, sold separately) which adds 37 to 69 in (94 to 175.2 cm) to the existing strap for big columns
- ▶ Weighs 5.10 lb (2.32 kg)

APPLICATIONS

- ▶ Perfect for lasers or Theodolites

4852-15 — Column Clamp

Safety Lighted Utility Vest 8565-Series

Retroreflective and Active Lightning Features minimize injury risk by making workers visible in dark or poorly lit environments

Coming Soon



FEATURES & BENEFITS

- ▶ Developed in conjunction with surveyors from the California Department of Transportation to improve safety without sacrificing functionality
- ▶ ANSI/ISEA Class 2 compliant
- ▶ Longer visibility range than standard reflective safety vest.
- ▶ Enhanced visibility without the need for incident / external light source.
- ▶ Fully certified ANSI / REACH / RoHS compliant
- ▶ 100% visibility – 360 degrees

THE VEST

- ▶ Made from durable ANSI/ ISEA compliant polyester and polyester mesh
- ▶ Features include YKK zippers, 4-inch (10.16 cm) wide reflective tape with 2-inch (5.08 cm) wide silver stripes made with 3M Scotchlite Reflective Material
- ▶ Padded collar is made with Outlast® Adaptive Comfort® material
- ▶ Tested for electromagnetic compliance
- ▶ Safe working in wet conditions
- ▶ Functional vest including many quality features (multiple pockets for cell phone, tapes, radio, pencils, maps, spray cans, inside pockets and mic clips)
- ▶ Soft reflective materials
- ▶ Polyester mesh with cooling properties for hot and humid conditions
- ▶ Available in Fluorescent Yellow or Fluorescent Orange

THE ACTIVE ILLUMINATION

- ▶ Flexible light and homogenous illumination
- ▶ Suitable for washing and drying process in apparels
- ▶ Guaranteed for at least 20 wash cycles (15 more than the standard requires)
- ▶ 8-hour battery life thanks to long-lasting batteries
- ▶ Low 5-volt voltage to ensure safety in wet working conditions
- ▶ EMC-tested and confirmed fault-free



- ▶ Power capacity 5000 mAh

Note: Item can be purchased separately

D13038 — SECO Power Bank 5000 mAh

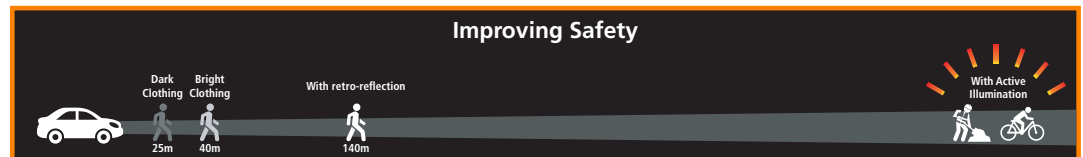
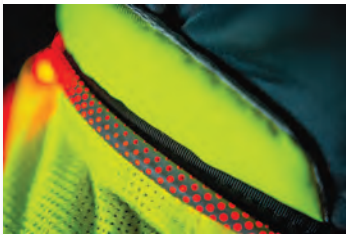

60mph – perception 88 ft – braking distance 180 ft = 268 ft (82 meters)

PART NO.	COLOR	SIZE	
8565-42-FLY	Fluorescent Yellow	42 (S)	
8565-42-FOR	Fluorescent Orange	42 (S)	
8565-46-FLY	Fluorescent Yellow	46 (M)	
8565-46-FOR	Fluorescent Orange	46 (M)	
8565-50-FLY	Fluorescent Yellow	50 (L)	
8565-50-FOR	Fluorescent Orange	50 (L)	
8565-54-FLY	Fluorescent Yellow	54 (XL)	
8565-54-FOR	Fluorescent Orange	54 (XL)	
8565-58-FLY	Fluorescent Yellow	58 (XXL)	
8565-58-FOR	Fluorescent Orange	58 (XXL)	
8565-62-FLY	Fluorescent Yellow	62 (XXXL)	
8565-62-FOR	Fluorescent Orange	62 (XXXL)	
8565-66-FLY	Fluorescent Yellow	66 (J)	
8565-66-FOR	Fluorescent Orange	66 (J)	

Safety Utility Vest 8365-Series

Designed to meet ANSI/ISEA Class 3 Standards



FEATURES & BENEFITS















- ▶ Made from durable ANSI/ISEA compliant polyester and polyester mesh
- ▶ Features include YKK™ zippers, 4 inch (10.16 cm) wide reflective tape with 2 inch (50.8 mm) wide silver stripes made with 3M Scotchlite® reflective material
- ▶ Adaptive Comfort® material

- by Outlast®, a Certified Space Technology™, designed to balance body temperature
- ▶ Developed in conjunction with surveyors from the California Department of Transportation
- ▶ Includes many quality features; multiple pockets for cell phone, tapes, radio, pencils, maps, spray cans and etc

- ▶ Plus, two inside pockets and comes with dual mic clips

APPLICATIONS

- ▶ Workplace safety
- ▶ Perfect for construction crews or surveyors near busy roads or other possibly hazardous locations where worker visibility is desired

PART NO.	COLOR	SIZE	
8365-42-FLY	Fluorescent Yellow	42 (S)	
8365-42-FOR	Fluorescent Orange	42 (S)	
8365-46-FLY	Fluorescent Yellow	46 (M)	
8365-46-FOR	Fluorescent Orange	46 (M)	
8365-50-FLY	Fluorescent Yellow	50 (L)	
8365-50-FOR	Fluorescent Orange	50 (L)	
8365-54-FLY	Fluorescent Yellow	54 (XL)	
8365-54-FOR	Fluorescent Orange	54 (XL)	
8365-58-FLY	Fluorescent Yellow	58 (XXL)	
8365-58-FOR	Fluorescent Orange	58 (XXL)	
8365-62-FLY	Fluorescent Yellow	62 (XXXL)	
8365-62-FOR	Fluorescent Orange	62 (XXXL)	
8365-66-FLY	Fluorescent Yellow	66 (J)	
8365-66-FOR	Fluorescent Orange	66 (J)	

Safety Utility Vest 8265-Series

Designed to meet ANSI/ISEA Class 2 Standards



FEATURES & BENEFITS















- ▶ Developed in conjunction with surveyors from the California DOT
- ▶ Features include bright fluorescent material, 4 inch (101.6 mm) wide contrasting reflective material with 2 inch (50.8 mm) wide silver stripes made of 3M™ Scotchlite™ reflective material

- ▶ Made of durable polyester, brass grommets, heavy-duty webbing and trim, and a genuine YKK™ zipper
- ▶ Adaptive Comfort® material by Outlast®, a Certified Space Technology™, designed to balance body temperature
- ▶ Features four large pockets on the outside and two generous pockets on the inside – great

- for field books, tapes, pencils, flagging, cell phones, etc
- ▶ Includes two spray can holders

APPLICATIONS

- ▶ Workplace Safety
- ▶ Perfect for construction crews or surveyors near busy roads or other possibly hazardous locations where worker visibility is desired

PART NO.	COLOR	SIZE	
8265-42-FLY	Fluorescent Yellow	42 (S)	
8265-42-FOR	Fluorescent Orange	42 (S)	
8265-46-FLY	Fluorescent Yellow	46 (M)	
8265-46-FOR	Fluorescent Orange	46 (M)	
8265-50-FLY	Fluorescent Yellow	50 (L)	
8265-50-FOR	Fluorescent Orange	50 (L)	
8265-54-FLY	Fluorescent Yellow	54 (XL)	
8265-54-FOR	Fluorescent Orange	54 (XL)	
8265-58-FLY	Fluorescent Yellow	58 (XXL)	
8265-58-FOR	Fluorescent Orange	58 (XXL)	
8265-62-FLY	Fluorescent Yellow	62 (XXXL)	
8265-62-FOR	Fluorescent Orange	62 (XXXL)	
8265-66-FLY	Fluorescent Yellow	66 (J)	
8265-66-FOR	Fluorescent Orange	66 (J)	

Safety Utility Vest 8068-Series

Designed to meet ANSI/ISEA Class 2 Standards



FEATURES & BENEFITS

- ▶ Durable fluorescent fabric is constructed of 100% polyester for softness, comfort, superior strength and abrasion resistance
- ▶ Features convenient pockets with sturdy fasteners, map

- pocket and mic clip
- ▶ Complies with ANSI/ISEA Class 2 standards for high-visibility safety apparel with two-inch-wide stripes of retroreflective tape
- ▶ Snaps on chest allow vest to close

APPLICATIONS

- ▶ Workplace Safety
- ▶ Perfect for construction crews or surveyors near busy roads or other possibly hazardous locations where worker visibility is desired

PART NO.	COLOR	SIZE	
8068-42-FLY	Fluorescent Yellow	42 (S)	
8068-42-FOR	Fluorescent Orange	42 (S)	
8068-46-FLY	Fluorescent Yellow	46 (M)	
8068-46-FOR	Fluorescent Orange	46 (M)	
8068-50-FLY	Fluorescent Yellow	50 (L)	
8068-50-FOR	Fluorescent Orange	50 (L)	
8068-54-FLY	Fluorescent Yellow	54 (XL)	
8068-54-FOR	Fluorescent Orange	54 (XL)	
8068-58-FLY	Fluorescent Yellow	58 (XXL)	
8068-58-FOR	Fluorescent Orange	58 (XXL)	
8068-62-FLY	Fluorescent Yellow	62 (XXXL)	
8068-62-FOR	Fluorescent Orange	62 (XXXL)	
8068-66-FLY	Fluorescent Yellow	66 (J)	
8068-66-FOR	Fluorescent Orange	66 (J)	

Safety Utility Vest 8069-Series

Designed to meet ANSI/ISEA Class 2 Standards



FEATURES & BENEFITS

- ▶ Vests are manufactured to meet ANSI/ISEA Class 2 standards
- ▶ Features a cool, comfortable mesh back and snaps in front to close vest

- ▶ 100% polyester
- ▶ Includes special compartments for notebooks, pencils, compass, flagging tape, etc
- ▶ Features exterior radio mic clip

APPLICATIONS

- ▶ Workplace Safety
- ▶ Perfect for construction crews or surveyors near busy roads or other possibly hazardous locations where worker visibility is desired

PART NO.	COLOR	SIZE	
8069-42-FLY	Fluorescent Yellow	42 (S)	
8069-42-FOR	Fluorescent Orange	42 (S)	
8069-46-FLY	Fluorescent Yellow	46 (M)	
8069-46-FOR	Fluorescent Orange	46 (M)	
8069-50-FLY	Fluorescent Yellow	50 (L)	
8069-50-FOR	Fluorescent Orange	50 (L)	
8069-54-FLY	Fluorescent Yellow	54 (XL)	
8069-54-FOR	Fluorescent Orange	54 (XL)	
8069-58-FLY	Fluorescent Yellow	58 (XXL)	
8069-58-FOR	Fluorescent Orange	58 (XXL)	
8069-62-FLY	Fluorescent Yellow	62 (XXXL)	
8069-62-FOR	Fluorescent Orange	62 (XXXL)	
8069-66-FLY	Fluorescent Yellow	66 (J)	
8069-66-FOR	Fluorescent Orange	66 (J)	

Hydration Backpack

Stay hydrated on the job while maintaining workplace safety



FEATURES & BENEFITS

- ▶ 20 x 8 inches (50.8 x 20.32 cm)
- ▶ Chest strap with side release buckle
- ▶ 4-inch (101.6 mm) wide fabric with 2-inch (50.8 mm) wide reflective tape (same as safety vest)
- ▶ 1-inch (25.4 mm) wide polypropylene webbing allows shoulder straps to adjust
- ▶ 1000D Cordura Nylon is bonded to the 1/4-inch (6.35 mm) back padding
- ▶ Neoprene sleeve surrounds the hydration tube

- ▶ Bladder size 2.5 liters (84.5 fl oz)
- ▶ When bladder is completely full the hydration pack is 5 inches (127 mm) thick
- ▶ Mod-U-Lox® keeps hydration tube secure on either strap, allowing access to the bite valve for either right- or left-handed use (one on each side)
- ▶ Weighs (with water) 6.70 lb (3.03 kg)
- ▶ Weighs (without water) 1.20 lb (0.54 kg)

Applications

- ▶ Workplace Safety
- ▶ Construction environment



8125-60-FOR — Hydration Backpack

Backpack Carrying System

Easy to mount backpack system with enhanced visibility for carrying all large instrument containers



FEATURES & BENEFITS

- ▶ Easy to mount carrying system backpack
- ▶ Compatible with all large total station models
- ▶ Comfortable padded straps and padded back
- ▶ Ideal solution to carry total station and accessories from one job site to another

- ▶ Made with Rhinotek® High grade abrasion resistant fabric
- ▶ Self illuminated high visibility features
- ▶ Weight: 4 lbs
- ▶ Measures: 24 x 12 x 5 inches (folded)

Applications

- ▶ Keeps your total station safe and secure during transportation
- ▶ Workplace safety
- ▶ Construction environment



PART NO.	COLOR	LED LIGHT	
D13035-BLK	Black	No	
D13035-BLK-LED	Black	Yes	
D13035-KHA	Khaki	No	
D13035-KHA-LED	Khaki	Yes	

Utility Bags and Miscellaneous Cases

Designed to keep your field equipment and supplies safe and secure

- ▶ Features four exterior deep-zippered pockets — two front and two side
- ▶ Two interior pockets — 14 x 12 x 2 inches with hook-and-loop closures
- ▶ Heavy-duty nylon webbing carrying straps
- ▶ Measures 30 x 14 x 20 inches (76.2 x 35.6 x 50.8 cm)
- ▶ Weighs 3.78 lb (1.72 kg)



8106-10-ORG — Monster Gear Bag

- ▶ Excellent for carrying surveying accessories, clothing, and other miscellaneous gear
- ▶ Made of heavy-duty water resistant polyester
- ▶ Measures 27 x 11 x 11 inches (69 x 28 x 28 cm)
- ▶ Weighs 1.56 lb (0.71 kg)



8106-20-ORG — Surveyor's Gear Bag with Rhinotek Bottom

- ▶ Fits most large controllers like the Ranger™ series, Allegro, TSC3™
- ▶ Features a Velcro® flap closure, belt loop and shoulder strap
- ▶ Main compartment measures 10.25 x 5.25 x 2 inches (26 x 13.3 x 5 cm)
- ▶ Padded with 0.25 in (6.35 mm) 1000D Cordura material with khaki trim
- ▶ Outside pocket is 6 x 5 in (15 x 12.7 cm)
- ▶ Weighs 0.35 lb (0.16 kg)



8142-01-ORG — Large Controllers Case

- ▶ Features include an outside pocket with a Velcro closure and 2 inch straps made with heavy-duty webbing
- ▶ Also features a Rhinotek™ and leather reinforced bottom
- ▶ Measures 10.25 x 15 inches (26 x 38 cm)
- ▶ Weighs 1.30 lb (0.59 kg)



8095-20-ORG — Heavy-Duty Collapsible Bucket Bag

- ▶ This case holds the Trimble® Pathfinder® ProXH™ or the ProXT™ GNSS unit securely
- ▶ Weighs 0.45 lb (0.20 kg)



8143-21-YEL — Trimble Pathfinder Series Pole Case

- ▶ Secure your cell phone to any survey pole without slipping
- ▶ Inside dimensions: 5 x 2.5 x 1.5 inches (12.7 x 6.35 x 3.81 cm)
- ▶ Weighs 0.10 lb (0.45 kg)



8143-22-FLY — GNSS Rod Cell Phone Case

- ▶ The MiFi Hotspot Case secures any MiFi unit to any GNSS survey pole or prism pole
- ▶ Easily attaches to a GNSS or prism pole with the metal clamp on case
- ▶ This pouch stays in place; it will not slip down the pole
- ▶ Features a window to clearly view the installed unit activity
- ▶ Works with all MiFi Hotspots and most smart phones on the market today
- ▶ A Velcro strap keeps unit safely inside clear pouch
- ▶ Inside dimensions 6 x 4.25 inches (15.24 x 10.8 cm)
- ▶ Constructed of heavy-duty Cordura®
- ▶ Comes in fluorescent yellow
- ▶ Weighs 0.35 lb (0.16 kg)



8143-40-FLY — MiFi Hotspot Case

Tool Pouches

Designed to keep your tools safe and organized

- ▶ Features include an 11 x 7 inch (28 x 18 cm) and 6 x 4 inch (15 x 10 cm) pouches
- ▶ Has slots for markers, a loop for axes or hammers
- ▶ Weighs 0.40 lb (0.18 kg)



8046-20-ORG — Construction-Style Tool Pouch

- ▶ Features a 9 x 2 x 11 inch (22.9 x 5.08 x 27.9 cm) pocket
- ▶ Large pocket is lined with two layers of 1000D Cordura
- ▶ Webbed belt adjusts to a 50 inch (127 cm) waist
- ▶ Includes a hammer loop and marker storage
- ▶ Weighs 1.05 lb (0.48 kg)



8046-30-ORG — Surveyor's Tool Pouch with Belt

GNSS Pole and Tripod Bags

Designed to keep your GNSS tripods and rods safe and secure

- ▶ This bag features heavy-duty Cordura® and reinforced Rhinotek™ material
- ▶ Shoulder strap is included
- ▶ Use with Heavy-Duty GNSS Antenna Tripods (5119-10)
- ▶ Measures: 8 inch ID x 56 inches (20.32 x 142.24 cm)
- ▶ Weighs 1.80 lb (0.82 kg)



8154-12-ORG — Heavy-Duty GNSS Tripod Bag 

- ▶ Replacement carrying case for Radio Antenna Tripod
- ▶ Case comes included when you purchased the Radio Antenna Tripod (5300-11 & 5300-12)
- ▶ Outside Dimensions: 8 inches x 54 inches



8154-10-ORG — Radio Antenna / Elevated Tripod Carrying Case 

- ▶ Use with our Collapsible GNSS Antenna Tripod (5119-00) or other conventional tripods
- ▶ Designed to carry the tripod without the point on the center pole to prevent damage to the pole
- ▶ Features a full length heavy-duty zipper
- ▶ Weighs 1.70 lb (0.77 kg)
- ▶ Inside Dimensions: 7" x 50"



8154-00-ORG — Collapsible GNSS Antenna Tripod Bag 

- ▶ Designed to protect the rods during transportation or storage
- ▶ 5.5 ID x 41 inches long with a 10" flap
- ▶ Weighs 0.45 lb (0.20 kg)



8162-00-ORG — GPS Rover Rod Carrying Case 

- ▶ Features a full-length zipper and shoulder strap
- ▶ Measures: 82 x 9 OD inches (208.28 x 22.86 OD cm)
- ▶ Weighs 1.88 lb (0.85 kg)



8153-10-ORG — Extra-Large Antenna / Elevated Tripod Carrying Case 

- ▶ This bag holds a 2 meter Snap-Lock pole and bipod or tripod (connected)
- ▶ Constructed of tough Cordura material and Rhinotek ends
- ▶ Measures 56 inches long (1.42 m)
- ▶ Weighs 1.50 lb (0.68 kg)



8151-02-FLY — Heavy-Duty Snap-Lock 2-Meter Pole System Bag 

Instrument Tripod Bags and Cases

Designed to keep your instrument tripods safe and secure

- ▶ The SECO Instrument Tripod Bag holds all major brands of aluminum and wooden tripods
- ▶ Made of heavy-duty nylon Cordura, with a Rhinotek bottom, and pull string ties at the top
- ▶ Measures: 52 x 8.75 OD inches (132 x 22.23 OD cm)
- ▶ 8150-20 weighs 1.85 lb (0.84 kg)



8150-20-ORG — Heavy-Duty Tripod Bag with Rhinotek Bottom 

- ▶ Heavy-duty bag for carrying many different brands of tripods, including SECO and Tri-Max
- ▶ Features zipper closure
- ▶ Measures: 48 x 8 OD inches (121.9 x 20.3 OD cm)
- ▶ Weighs 1.80 lb (0.82 kg)



8154-11-ORG — Super-Duty Tripod Bag 

Rover Rods and Prism Pole Tripod Cases

Designed to keep your Rover rod, Robotics pole and Prism pole tripods safe and clean

- ▶ Store your two-piece rover rod in this hard shell case and know it's protected
- ▶ Measures 4 ID x 41 in (10.16 ID x 104.14 cm)
- ▶ Weighs 3.20 lb (1.40 kg)



8162-20-BLK — GNSS Rover Rod Hard Shell Case

- ▶ External and internal side pockets hold extra gear
- ▶ Measurements: 6 OD x 58 inches (15.25 OD x 147.32 cm)
- ▶ Weighs 2.70 lb (1.23 kg)



8157-01-ORG — Long Padded System Bag

- ▶ Designed to carry a prism pole bipod or tripod attached
- ▶ Has a fold-over flap and shoulder strap
- ▶ Made from nylon Cordura and durable Rhinotek
- ▶ Measures: 7.5 ID x 60 inches (19.1 ID x 152 cm)
- ▶ Weighs 1.55 lb (0.70 kg)



8180-20-ORG — Heavy-Duty Prism Pole Bipod/Tripod Bag

- ▶ Protect your prism or range pole from dirt and moisture
- ▶ Measures: 61.5 x 6 in (156.21 x 15.24 cm)
- ▶ Weighs 0.68 lb (0.31 kg)



8160-00-ORG — Prism or Range Pole Protective Bag

- ▶ The heavy-duty material-covered tube holds one- or two-section poles or rods
- ▶ Measures: 65 inches (1.63 m) in length
- ▶ Use to protect and carry your pole or rod
- ▶ Weighs 5.50 lb (2.50 kg)



8160-20-BLK — Prism Pole Hard Shell Case

Assorted Rod Carrying Cases

Designed to keep your One Shot, DE rod, Range pole, LR-STD, LR-PRO and CR rod safe and clean

- ▶ This carrying case is made from the highest quality 1000-denier nylon
- ▶ Water-resistant
- ▶ Measures: 4.5 x 82 inches (11.4 x 208.3 cm)
- ▶ Weighs 0.45 lb (0.20 kg)



91402 — LR-STD/LR-PRO Carrying Case

- ▶ Fits 13 ft (4 m), 16 ft (5 m) and 20 ft (6 m) rods
- ▶ Made from 1000-denier nylon
- ▶ Water-resistant
- ▶ Measures: 4.25 x 65.5 inches (10.8 x 166.4 cm)
- ▶ Weighs 0.45 lb (0.20 kg)



91411 — CR-13/16/20 ft / SVR-17/25 Carrying Case

- ▶ Textured heavy-duty poly
- ▶ Measures 7.5 x 46 inches (19.05 x 116.84 cm)
- ▶ Weighs 0.48 lb (0.22 kg)



8170-00-ORG — Range Pole Case

- ▶ Fits 8 ft (2.4 m) rods
- ▶ Made from 1000-denier nylon
- ▶ Water-resistant
- ▶ Measures: 3.5 x 56.5 inches (8.9 x 143.5 cm)
- ▶ Weighs 0.30 lb (0.14 kg)



91410 — CR-8 ft/2.4m Carrying Case

BACK BY POPULAR DEMAND!

This DE Rod Bag, previously discontinued, has been brought back through customer requests

- ▶ Extremely durable Cordura(R) bag with reinforced bottom
- ▶ Pocket for a sensor bracket
- ▶ Shoulder strap included
- ▶ 4 x 71 inch (10.16 x 180.34 cm)
- ▶ Weighs 0.5 lb (0.23 kg)



8166-01-ORG — Direct Elevation Rod Bag

CMR Measuring Ruler Cases

- ▶ Made from the highest-quality 1000-denier nylon.
- ▶ For use with our rugged fiberglass CMR Series Measuring Rulers 90180, 90181 and 90182, and for gopher pole 90520 on page 53.

PART NO.	SIZE	
91415	3.5 x 65 in (8.89 x 165.1 cm)	
91416	4.5 x 68 in (11.43 x 172.72 cm)	
91417	4.5 x 76 in (11.43 x 193.04 cm)	



Lath and Stake Bags

Designed to hold your lath and stakes secure

- ▶ Carries up to 50 lath or rebar
- ▶ Measures 9 x 38 inches (2.54 x 96.52 cm)
- ▶ Weighs 0.22 lb (0.10 kg)



8102-01-ORG — 38 inch Lath Carrier

- ▶ Carries up to 50 lath or rebar
- ▶ Measures 9 x 38 inches (2.54 x 96.52 cm)
- ▶ Weighs 0.22 lb (0.10 kg)



8102-00-ORG — 38 inch Lath Carrier

- ▶ Use to carry 21 inch (53 cm) or 30 inch (76 cm) flags
- ▶ 8093-00-ORG weighs 0.22 lb (0.10 kg)
- ▶ 8094-00-ORG weighs 0.28 lb (0.13 kg)



8093-00-ORG — Wire Stake Flag Bag for 21 in Flags
8094-00-ORG — Wire Stake Flag Bag for 30 in Flags

- ▶ Holds 24 inch (61 cm) wood lath
- ▶ Features a hand loop, shoulder strap, outside pocket
- ▶ 8 inch (20.3 cm) inside diameter
- ▶ Weighs 0.40 lb (0.18 kg)



8103-20-ORG — Heavy-Duty Rhinotek Lath Bag

- ▶ Heavy-duty lath carrier fits 36 or 48-inch lath
- ▶ Features space inside for any standard 12 inch, five-gallon bucket
- ▶ Weighs 1.50 lb (0.68 kg) without bucket and approx. 3.85 lb (1.75 kg) with bucket added



8104-20-ORG — Heavy-Duty Bucket Lath Carrier

- ▶ The main compartment of this bag is constructed of tough Rhinotek™ material and designed to hold 18 inch stakes or rebar
- ▶ Include hammer loop, adjustable strap and brass grommet drain holes — the 8091-20-ORG features a partition
- ▶ Standard bag weighs 1.55 lb (0.70 kg)
- ▶ Partitioned bag weighs 1.70 lb (0.77 kg)



8090-20-ORG — Heavy-Duty 18-inch Bag for Stakes or Rebar
8091-20-ORG — Heavy-Duty 18-inch Bag w/ Center Partition

- ▶ Heavy-Duty Lath Bag but with Rhinotek material on the bottom and six inches up the sides
- ▶ Designed in two sizes: 8 inches wide by 36 or 48 inches deep
- ▶ Both weigh approximately 1.50 lb (0.68 kg)



8100-20-ORG — 36 inch Heavy-Duty Lath or Rebar Bag
8101-20-ORG — 48 inch Heavy-Duty Lath or Rebar Bag

- ▶ This stake bag is the same as the 8090-20-ORG, but holds 24 inch stakes
- ▶ Features a Rhinotek bottom
- ▶ Standard bag weighs 1.70 lb (0.77 kg)
- ▶ Partitions bag weighs 1.60 lb (0.73 kg)



8092-20-ORG — Heavy-Duty 24-inch Bag for Stakes or Rebar
8096-20-ORG — Heavy-Duty 24-inch Bag w/ Center Partition

- ▶ Choose between a standard spray can holder or a holder with updated features like four pockets for pens/pencils and a heavy web strap
- ▶ Both weighs approximately 1.00 lb (0.45 kg)



8098-00-ORG — Standard Spray Can Holder
8098-10-ORG — With Accessory Pockets (shown)

Front and Top Loading Total Station Cases

Heavy-duty cases for your Total Station



FEATURES & BENEFITS

- ▶ Features a Rhinotek™ bottom and durable backpack straps

- ▶ Measures between the pads: 14 x 9 x 7 in (35.6 x 22.9 x 17.8 cm)

Applications

- ▶ Keeps your total station safe and secure during transport

PART NO.	LOADING SPACE	FEATURES	WEIGHS
8120-00-ORG	Front Loading	Cloth Frame	5.75 lb (2.61 kg)
8121-00-ORG	Top Loading	Cloth Frame	5.75 lb (2.61 kg)
8123-00-ORG	Top Loading	Aluminum Frame	7.50 lb (3.40 kg)

Total Station, GIS and GNSS Backpacks

Designed to keep your Total Station, GIS and GNSS equipment safe and secure

- ▶ This pack includes a cam-lock antenna pole, adjustable straps, several interior pockets, belt loop straps, rain flap and much more
- ▶ Interior dimensions (measured between the pads): 15 x 9 x 4 in
- ▶ Pole extends from 15 7/8 to 32 inches (40.3 to 81.3 cm)
- ▶ Has 5/8 x 11 tip on antenna pole
- ▶ Weighs 2.00 lb (0.91 kg)



8125-50-ORG — Small GIS Backpack 
D10694-T — Replacement Range Pole, Twist Lock 

- ▶ The Total Station Backpack is similar in style to a commercially available lightweight day pack
- ▶ Main compartment has an innovative 'wrap' made of 3/8-inch high-density foam with hook and loop adjustment that securely cradles all total stations
- ▶ Features extra pockets and Rhinotek™ bottom
- ▶ 8120-40: Height – 18" (46 cm), Bottom – 9" X 10" (23 cm x 25 cm)
- ▶ 8120-30: Height – 15" (38 cm), Bottom – 7" X 9" (18 cm x 23 cm)
- ▶ Weighs 2.40 lb (1.10 kg)



8120-30-ORG — 400 mm Total Station Backpack (shown) 
8120-40-ORG — 500 mm Total Station Backpack 

- ▶ Features a double-zipped, top-loading station compartment lined with rigid foam padding, two side pockets for cables, and one front battery pocket
- ▶ Comfortable padded belt with lumbar back support system, shoulder straps with all-point adjustment features, and a rubberized carrying handle
- ▶ The free-standing aluminum frame keeps the pack upright even when fully loaded
- ▶ Has a top rain flap with closure and rain flaps on the side pockets
- ▶ Features a Rhinotek bottom
- ▶ Interior dimensions (measured between the pads): 17 x 10 x 10 in
- ▶ Exterior dimensions: 24.5 x 15 x 16 in
- ▶ Weighs 8.00 lb (3.62 kg)
- ▶ Holds 40 lb (18.14 kg)



8134-00-ORG — Robotics Backpack 

- ▶ This pack, which includes cool mesh and foam back pad, offers a convenient and comfortable way to transport and manage GIS instrumentation
- ▶ Features include a built-in pocket for CamelBak® or other hydration systems
- ▶ Includes a protective rain flap
- ▶ Also features adjustable internal pockets; padded, adjustable shoulder straps, and waist belt
- ▶ Constructed of heavy-duty, high-vis polyester
- ▶ Interior dimensions: 20 x 9.5 x 4 in
- ▶ Includes a 5/8 x 11 tip
- ▶ Weighs 2.80 lb (1.27 kg)



8125-11-ORG — Large GIS Backpack with Cam-Lock Antenna Pole 

Prism and Tribrach Bags make excellent tablet bags for the field!

Prism and Tribrach Bags

Designed to keep prisms and tribrachs secure

- ▶ Heavily padded for single prisms
- ▶ Interior dimensions (measured between the pads): 5 x 7 x 2 inches
- ▶ Weighs 0.48 lb (0.22 kg)



8070-00-ORG — Single Prism Bag 

- ▶ For triple prisms and prism targets or tribrachs
- ▶ Interior dimensions (measured between the pads): 10 x 9.5 x 3 inches
- ▶ Weighs 1.06 lb (0.48 kg)



 8081-00-ORG — Jumbo Triple Prism Bag

- ▶ Heavily padded for triple prisms
- ▶ Interior dimensions (measured between the pads): 9 x 7 x 2 inches
- ▶ Weighs 0.75 lb (0.34 kg)



 8080-00-ORG — Triple Prism Bag

- ▶ Easily holds a tribrach
- ▶ Interior dimensions (measured between the pads): 6 x 6 x 2 inches
- ▶ Weighs 0.40 lb (0.18 kg)



8071-00-ORG — Tribrach Case 

- ▶ Holds a tilting prism with tribrach and adapter
- ▶ Interior dimensions (measured between the pads): 12 x 12 x 3 inches
- ▶ Weighs 1.85 lb (0.84 kg)



8082-00-ORG — Super Jumbo Padded Bag 

- ▶ Designed for vertical triple prism assemblies
- ▶ Holds target with tribrach and adapter
- ▶ Interior dimensions (measured between the pads): 15 x 8 x 2 inches
- ▶ Available in Orange
- ▶ Weighs 1.45 lb (0.66 kg)



8130-00-ORG — Tall Triple Prism Bag 

**ChrisNik MagNails®,
MagSpikes® and MagHubs®**

Corrosion resistant and magnetized for easy detection

- ▶ Mag Nails have been coated with an environmentally friendly zinc and clear chromate to resist corrosion
- ▶ Stronger, more durable, higher quality, magnetic and longer lasting than other nails
- ▶ Mag Nails are larger and magnetic making them easier to locate using the naked eye or a locator
- ▶ Each box includes 100 Mag Nails

- ▶ Constructed of premium steel that produces the most durable survey marker in the industry
- ▶ Like the Mag Nail the Mag Spike is magnetized for easy detection
- ▶ Featuring a large center point and 1-inch (25.4 mm) diameter head makes it great for control points and property corners
- ▶ Made in the USA

- ▶ The Mag Hub is magnetized for easy detection and zinc plated to resist corrosion
- ▶ Featuring a large center point and looks like a standard survey marker
- ▶ Not made to be driven into asphalt or concrete
- ▶ Easy to carry and less expensive than stakes
- ▶ Mag Hubs come in a 30 lb (13.61 kg) box approximate quantities are below



PART NO.	SIZE	QUANTITY	WEIGHTS
ChrisNik MagNails			
24750-CS	3/4 x 1/8 inch	100 per box, 12 box per case	7 lb/case
241000-CS	1 x 5/32 inch	100 per box, 12 box per case	11 lb/case
241250-CS	1 1/4 x 3/16 inch	100 per box, 12 box per case	18 lb/case
241500-CS	1 1/2 x 1/4 inch	100 per box, 12 box per case	33 lb/case
242000-CS	2 x 1/4 inch	100 per box, 12 box per case	41 lb/case
242500-CS	2 1/2 x 1/4 inch	100 per box, 12 box per case	48 lb/case
ChrisNik MagSpikes			
253MAGSPIKE	3/8 x 3 inch	25 per box	2.5 lb (1.13 kg)
256MAGSPIKE	3/8 x 6 inch	20 per box	4.00 lb (1.18 kg)
258MAGSPIKE	3/8 x 8 inch	20 per box	5.00 lb (2.27 kg)
ChrisNik MagHubs			
23MAGHUB6	1/4 x 6 inch	Approx...367	30.00 lb (13.61 kg)
23MAGHUB8	1/4 x 8 inch	Approx...272	30.00 lb (13.61 kg)

Flagging Dispenser





- ▶ The steel Presco Roll Flagging Belt Dispenser is a convenient time-saver
- ▶ Weighs 1.30 lb (0.59 kg)

8025-00-ORG — Padded Flagging Dispenser

Miscellaneous Accessories



- ▶ Choose between a 17.5 inch blade and a 13 inch blade for clearing that thick underbrush on the job site
- ▶ Weighs approx. 1.00 lb (0.45 kg)



9500-17 — 17.5 inch blade, includes sheath 
 9500-13 — 13 inch blade, includes sheath 

- ▶ 9500-01 for knife and scissor sharpening
- ▶ 9500-02 for Axes or other edged tool sharpening
- ▶ 9500-01 weighs 0.05 lb (0.02 kg)
- ▶ 9500-02 weighs 0.20 lb (0.09 kg)



9500-01 — For knives and scissors 
 9500-02 — For hand tools 

- ▶ Shot bags are great for holding down maps or blueprints in windy conditions
- ▶ Weighs 1.50 lb (0.68 kg)



8010-10-BLU — Cordura Shot Bag 

- ▶ Lightweight aluminum center punches are great for marking a variety of materials or punching starter holes for nails or drill bits
- ▶ Durable removable-tip scribes are perfect for making quick and accurate marks on hard work pieces
- ▶ The scriber features a durable tungsten carbide point that is able to make precise marks to 1/100th of an inch
- ▶ The magnetic cap quickly cleans up stray metal shavings



9068-02 — Heavy-Duty Center Punch 
 9068-03 — Carbide Scriber 

- ▶ Replacement caps and points fit all SECO plumb bobs



6000-001 — Plumb Bob Cap 
 6000-002 — Plumb Bob Point 

- ▶ Pin cushion for holding stake tacks



25456855 — Stake Tacks 1 LB 
 2180-00 — Regular Tac Ball 
 2180-01 — Tac Ball with Clip 

- ▶ The 3/16 inch spring steel, 14 inch pins are powder-painted red and white, alternating at each inch
- ▶ Quiver (8041-00-ORG) sold separately
- ▶ Weighs 1.54 lb (0.70 kg)



2183-00 — Marking Pins 11 count 

- ▶ **6001-06**
- ▶ Gammon Reel® Plumb Line Reel for Surveyors
- ▶ Designed for use in the surveying field
- ▶ 6-1/2 foot (1.9m) orange string
- ▶ Quickly retracts eliminating tangled string



- ▶ **6001-12**
- ▶ Gammon Reel® Plumb Line Reel
- ▶ Designed for use in the construction field
- ▶ 12 foot (3.6m) fluorescent red string
- ▶ Mylar® protected target also serves as a sight
- ▶ Quickly retracts eliminating tangled string

6001-06 — Gammon Reel 6.5 ft (1.9m) 
 6001-12 — Gammon Reel 12 ft (3.7 m) 



- ▶ 24 yard (7.3m) bobbin of Gammon Reel refill cord
- ▶ Available in Flo Red and Orange



6001-FR — Gammon Reel Refill - Flo Red 
 6001-OR — Gammon Reel Refill - Orange 

- ▶ Each solid brass bob features a hardened steel point and a storage area for a spare point



6000-012	12 oz	340 g	
6000-014	14 oz	397 g	
6000-016	16 oz	454 g	
6000-018	18 oz	510 g	
6000-024	24 oz	680 g	
6000-032	32 oz	907 g	

- ▶ Heavy-duty sheath is double stitched top grain leather with a belt loop for SECO plumb bobs



6000-120 — Leather Sheath for 10-12 oz (283-340 g) 
 6000-160 — Leather Sheath for 14-18 oz (397-454 g) 
 6000-240 — Leather Sheath for 24-32 oz (510-907 g) 

- ▶ 10 lb of Shiners with bag included
- ▶ Approximate qty: 1,125
- ▶ Weighs 10.00 lb (4.53 kg)



2181-10 — Bulk Shiners - Flat 

- ▶ Raised Shiners are 1.94 in (49.3 mm) OD
- ▶ Features a raised 29 mm center
- ▶ Weighs 1.00 lb (0.45 kg)



2182-00 — Raised Shiners, 260 count 

- ▶ Flat shiners are 2.25 in (57.2 mm) OD
- ▶ Featuring punched centers with crimped edges
- ▶ Weighs 2.60 lb (1.18 kg)



2181-00 — Flat Shiners, 250 count 

Rite in the Rain

- ▶ Rite in the Rain bound books ensure that your valuable data won't be lost
- ▶ These all-weather books have 160 pages (80 sheets), including a title and contents page
- ▶ This 4-3/4 x 7-1/2 inch yellow field book also features a sewn binding
- ▶ Books sold individually
- ▶ Weighs 0.65 lb (0.29 kg)

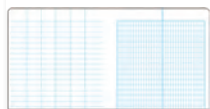

Transit Pattern
8 vertical lines
to the inch

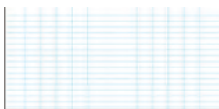

Level Pattern
6 vertical columns
on the page

300F — Transit Pattern Bound Book

310F — Level Pattern Bound Book

- ▶ Overall Size: 4.625 x 7 inches (11.75 x 17.78 cm)
- ▶ Cover Material: field flex
- ▶ Binding: side stapled
- ▶ Number of Pages: 48 (numbered)
- ▶ Number of Sheets: 24
- ▶ Books sold individually
- ▶ Weighs 0.56 lb (0.25 kg)



311FX — Level pattern Side-stapled Notebook for Tough Conditions

301FX — Transit pattern Side-stapled Notebook for Tough Conditions

- ▶ Overall Size: 4.625 x 7 inches (11.75 x 17.78 cm)
- ▶ Soft Cover Material: Polydura (recycled material)
- ▶ Binding: side-spiral
- ▶ Number of Pages: 64 (32 sheets)
- ▶ Books sold individually
- ▶ Weighs 0.20 lb (0.09 kg)



303 — Transit pattern Recyclable Side-spiral Notebook

353 — Field pattern Recyclable Side-spiral Notebook



PART NUMBER	PAGE	PART NUMBER	PAGE	PART NUMBER	PAGE	PART NUMBER	PAGE	PART NUMBER	PAGE
4 520 800	38	2153-04-BLK	41	5114-01	14	5144-00-FLY	27	5200-064	8
23MAGHUB6	71	2153-10-BLK	41	5114-02	14	5144-02	27	5200-065	8
23MAGHUB8	71	2159-01-BLK	40	5114-050	14	5145-00-FLY	27	5200-070	8
253MAGSPIKE	71	2159-04-BLK	40	5114-051	14	5145-02	27	5200-072	8
256MAGSPIKE	71	2159-050	40	5114-10	14	5145-03	27	5200-073	8
258MAGSPIKE	71	2180-00	72	5114-20-XXX	16	5150-02-WOR	27	5200-074	8
300F	73	2180-01	72	5114-21-XXX	16	5160-02-WOR	27	5200-075	8
301FX	73	2181-00	72	5114-40-01	17	5180-00	11	5200-076	8
303	73	2181-10	72	5114-40-02	17	5181-00	11	5200-077	8
310F	73	2182-00	72	5115-00-FLY	5	5182-001	27	5200-079	8
311FX	73	2183-00	72	5115-00-YEL	5	5187-00	13	5200-150	9
353	73	3003-06	52	5119-00-FLY	5	5187-00-SS	13	5200-151	9
2001-00	41	3003-07	52	5119-00-FOR	5	5190-00-KIT	26	5200-152	9
2002-00	41	3003-10	52	5119-00-YEL	5	5191-00	26	5200-154	9
2010-00	41	3006-06	52	5119-10-FLY	5	5192-00	26	5200-155	9
2020-00	41	3006-07	52	5119-10-YEL	5	5192-02	26	5200-16-050	7
2070-00	41	3006-10	52	5125-00-YEL	11	5193-04	26	5200-160	9
2070-02	20	3006-11	52	5125-01-YEL	11	5194-00	26	5200-164	9
2071-00	41	3006-18	52	5125-050	14	5194-003-KIT	26	5200-165	9
2072-050	5	4300-KR	55	5125-056	14	5194-007-KIT	26	5200-166	9
2072-30	5	4769-00	52	5125-057-FLY	14	5194-01	26	5200-167	8
2072-31	5	4769-01	52	5125-06-YEL	11	5194-03-KIT	26	5200-17-050	7
2072-32	5	4769-02	52	5125-20-FLY	12	5194-04	26	5200-201	9
2072-33	5	4769-03	52	5125-20-YEL	12	5194-05-KIT	26	5200-29-050	7
2072-51	38	4769-04	52	5125-22-FLY	12	5194-10	26	5200-30	7
2072-52	38	4769-06	52	5126-10	14	5194-10-002	26	5200-31	7
2080-00	11	4769-14	52	5128-00	11	5195-01	26	5200-32	7
2080-SS	11	4770-00	52	5128-052	14	5196-02	10	5200-33	7
2090-00	12	4770-01	52	5128-08	11	5196-07	10	5200-35	7
2090-01	13	4811-24	56	5128-20	12	5196-17	10	5200-39-052	6
2090-02	13	4811-32	56	5128-22	12	5196-18	10	5200-41	7
2090-04	13	4852-14	57	5128-24	12	5196-19	10	5200-41	7
2090-06	13	4852-15	61	5129-50	11	5196-20	10	5200-42	7
2090-07	13	4852-16	61	5129-51	11	5196-22	10	5200-43	7
2090-10	23	4852-17	60	5129-52	21	5198-052	9	5200-45	8
2090-11	23	4852-18	61	5129-52-SW	21	5198-054	9	5200-95	6
2090-12	23	4900-00	26	5129-53	21	5198-055	9	5200-96	6
2090-13	23	5001-10	18	5129-53-SW	21	5198-056	9	5214-00	29
2090-14	23	5001-12	18	5129-54	21	5198-059	9	5214-01	27
2090-15	23	5001-20	18	5129-70	11	5198-073	9	5216-00	35
2090-17	23	5010-00-FLY	22	5129-71	11	5198-081	9	5217-04-FLY	28
2090-19	23	5010-00-RED	22	5129-72	21	5198-086	10	5217-04-FOR	28
2090-21	23	5010-01	22	5129-72-SW	21	5198-152	9	5217-04-RED	28
2090-26	23	5070-051-40	18	5129-73	21	5198-153	9	5217-04-YEL	28
2120-00	14	5079-066	23	5129-73-SW	21	5198-157	25	5217-05-FLY	29
2130-00	14	5081-052-40	18	5130-00-FLY	27	5198-163	25	5217-05-FOR	29
2131-00	11	5110-00-FLY	27	5130-01-FLY	27	5198-52	17	5217-05-RED	29
2131-01	11	5110-00-RED	27	5130-10	27	5199-050	9	5217-05-YEL	29
2132-01	14	5110-01-FLY	27	5131-00-YEL	27	5199-051	9	5217-072	28
2133-03	10	5111-00	13	5131-01-FLY	27	5199-052	9	5217-15-ABK	13
2133-05	10	5111-00-SS	13	5132-00-ACL	27	5199-054	9	5217-20-FLY	48
2133-06	14	5111-04	14	5139-02-FLY	14	5200-050	8	5217-21-FOR	48
2152-04-BLK	41	5111-04-051	14	5140-02-WOR	27	5200-058	8	5217-30	29
2152-05-BLK	41	5113-012	14	5143-00-FLY	27	5200-059	8	5217-40-FLY	28
2153-02-BLK	41	5113-012	14	5143-02	27	5200-062	8	5217-40-RED	28

PART NUMBER	PAGE	PART NUMBER	PAGE	PART NUMBER	PAGE	PART NUMBER	PAGE	PART NUMBER	PAGE
5217-40-YEL	28	5527-16	12	6001-12	72	6600-03	38	7341-40	49
5218-02-FLY	29	5527-17	12	6001-FR	72	6600-04	38	7341-41	49
5218-02-FOR	29	5527-20	12	6001-OR	72	6600-05	38	7341-45	49
5218-02-RED	29	5527-22	12	6020-01	39	6600-10	36	7341-51	49
5218-02-YEL	29	5527-30	12	6020-02	39	6601-01	39	7341-52	49
5218-06-FLY	28	5530-10	25	6200-10-FOR	35	6601-01	48	7341-55	49
5218-06-FOR	28	5530-20	25	6200-11-FOR	35	6601-02	39	7341-56	49
5218-06-RED	28	5530-30	25	6341-00	34	6601-03	39	7400-10	51
5218-06-YEL	28	5531-10	25	6341-11	34	6601-04	39	7400-20	51
5218-15-ABK	29	5531-20	25	6400-00	34	6602-03	60	7400-30	51
5218-40-FLY	29	5531-30	25	6400-10	34	6603-00	37	8010-10-BLU	72
5218-40-RED	29	5540-10	24	6401-00-YEL	13	6603-00-005-TMB	37	8025-00-ORG	71
5218-40-YEL	29	5540-20	24	6402-02-FLB	31	6603-00-050	37	8030-00-CABLU	55
5219-03	28	5540-30	24	6402-02-FOB	31	6603-01	37	8046-10-BLU	17
5219-05	28	5541-10	24	6402-02-YLB	31	6603-01-051	37	8046-20-ORG	66
5220-13-BLK	45	5541-20	24	6402-03-FLB	31	6603-03	39	8046-30-ORG	66
5220-13-ORG	45	5541-30	24	6402-03-FOB	31	6603-05	38	8068-42-FLY	64
5300-11	6	5561-20	6	6402-03-YLB	31	6603-06	38	8068-42-FOR	64
5300-12	6	5600-10	24	6402-05-FOB	31	6604-20-G	37	8068-46-FLY	64
5301-21-BLK	46	5610-00	47	6402-05-YLB	32	6604-20-R	37	8068-46-FOR	64
5301-21-ORG	46	5610-01	47	6402-06-FLB	32	6605-60M-G	37	8068-50-FLY	64
5301-24-BLK	46	5610-11	47	6402-06-FOB	32	6605-60M-R	37	8068-50-FOR	64
5301-25-BLK	46	5610-12	47	6402-06-YLB	32	6606-04-20	37	8068-54-FLY	64
5301-31-BLK	45	5610-15	46	6402-10-FLB	32	6606-04-30	37	8068-54-FOR	64
5301-31-ORG	45	5631-10	25	6402-10-FOB	32	6606-04-40	37	8068-58-FLY	64
5302-13-BLK	44	5631-20	25	6402-10-YLB	32	6703-001	19	8068-58-FOR	64
5302-13-ORG	44	5631-30	25	6402-20-FLB	31	6703-002	20	8068-62-FLY	64
5311-21-ORG	46	5700-10	23	6402-20-FOB	31	6703-005	20	8068-62-FOR	64
5321-16-BLK	45	5700-20	23	6402-20-YLB	31	6703-007	20	8068-66-FLY	64
5321-17-ORG	44	5700-21	22	6405-01-FLY	35	6703-008	20	8068-66-FOR	64
5401-21-BLK	46	5720-10	23	6405-01-FOR	35	6703-011	19	8069-42-FLY	64
5401-24-BLK	46	5801-052-40	18	6405-10-FOR	35	6703-012	20	8069-42-FOR	64
5402-13-BLK	44	5801-10	24	6405-11-FLY	35	6703-013	20	8069-46-FLY	64
5402-13-ORG	44	5802-10	22	6405-11-FOR	35	6703-014	20	8069-46-FOR	64
5420-13-BLK	45	5802-20	22	6405-12-FOR	35	6703-015	19	8069-50-FLY	64
5420-13-ORG	45	5813-10	24	6405-13-FLY	35	6703-10	20	8069-50-FOR	64
5500-064-40	18	5901-00-FLY	27	6406-00	34	6703-11	20	8069-54-FLY	64
5500-11	23	5902-00-FLY	27	6406-01	33	6703-20	20	8069-54-FOR	64
5500-21	23	5910-01-ARD	36	6406-02	33	6704-001	19	8069-58-FLY	64
5500-23	22	5910-02-ARD	36	6410-00	34	6704-002	19	8069-58-FOR	64
5500-30	23	5910-05	36	6410-018	34	6704-003	19	8069-62-FLY	64
5501-11	22	5910-06	36	6411-00	39	6704-004	19	8069-62-FOR	64
5503-30	22	5910-24	36	6411-02-BLK	39	6704-10	19	8069-66-FLY	64
5512-11	23	6000-001	72	6411-03-BLK	39	6704-10-CASE	19	8070-00-ORG	70
5512-13-FLY-GM	12	6000-002	72	6411-04-BLK	39	6705-10	21	8071-00-ORG	70
5512-14-FOR-GM	12	6000-012	72	6416-00	39	6705-20	21	8080-00-ORG	70
5512-14-FOR-GT	12	6000-014	72	6422-02-FOB	31	6705-30	15	8081-00-ORG	70
5520-11	23	6000-016	72	6422-02-YLB	31	7301-30	49	8082-00-ORG	70
5520-21	23	6000-018	72	6422-20-YLB	31	7301-40	49	8082-01-ORG	20
5520-30	23	6000-024	72	6440-00-FOR	33	7301-50	49	8090-20-ORG	69
5521-11	22	6000-032	72	6450-00-BLK	36	7304-01	48	8091-20-ORG	69
5527-10	12	6000-120	72	6455-00	33	7321-050	48	8092-20-ORG	69
5527-11	12	6000-160	72	6600-01	38	7321-30	49	8093-00-ORG	69
5527-13	12	6000-240	72	6600-01-001	39	7321-40	49	8094-00-ORG	69
5527-15	12	6001-06	72	6600-02	38	7321-50	49	8095-20-ORG	66

PART NUMBER	PAGE	PART NUMBER	PAGE	PART NUMBER	PAGE	PART NUMBER	PAGE	PART NUMBER	PAGE
8096-20-ORG	69	8365-42-FOR	63	90558-050	43	99004	54	D11234	18
8098-00-ORG	69	8365-46-FLY	63	90558-052	43	99023	54	D11234	18
8098-10-ORG	69	8365-46-FOR	63	90560	42	99043	54	D11241	18
8100-20-ORG	69	8365-50-FLY	63	90582	44	99051	54	D11242	18
8101-20-ORG	69	8365-50-FOR	63	91014	48	99052	54	D11243	18
8102-00-ORG	69	8365-54-FLY	63	91100	49	99053	54	D12560	19
8102-01-ORG	69	8365-54-FOR	63	91133	48	99060	55	D13035-BLK	65
8103-20-ORG	69	8365-58-FLY	63	91162	49	99061	55	D13035-BLK-LED	65
8104-20-ORG	69	8365-58-FOR	63	91163	49	99062	55	D13035-KHA	65
8106-10-ORG	66	8365-62-FLY	63	91255	48	99063	55	D13035-KHA-LED	65
8106-20-ORG	66	8365-62-FOR	63	91258	48	99064	55	D13038	62
8120-00-ORG	69	8365-66-FLY	63	91275	48	99065	55	DE-50	57
8120-30-ORG	70	8365-66-FOR	63	91402	68	99066	55	DET-2	57
8120-40-ORG	70	8565-42-FLY	62	91410	68	99067	55	ML-1	53
8121-00-ORG	69	8565-42-FOR	62	91411	68	99068	55	ML-1-050	53
8123-00-ORG	69	8565-46-FLY	62	91415	53	99069	55	ML-1M	53
8125-11-ORG	70	8565-46-FOR	62	91415	68	99070	55		
8125-50-ORG	70	8565-50-FLY	62	91416	68	99071	54		
8125-60-FOR	65	8565-50-FOR	62	91417	68	99072	54		
8130-00-ORG	70	8565-54-FLY	62	91535	48	99079	54		
8134-00-ORG	70	8565-54-FOR	62	91601	26	99080	54		
8142-01-ORG	66	8565-58-FLY	62	91605	26	99081	54		
8143-21-YEL	66	8565-58-FOR	62	91641	26	241000-CS	71		
8143-22-FLY	66	8565-62-FLY	62	92001	51	241250-CS	71		
8143-40-FLY	66	8565-62-FOR	62	92002	51	241500-CS	71		
8150-20-ORG	67	8565-66-FLY	62	92021	51	242000-CS	71		
8151-02-FLY	67	8565-66-FOR	62	92022	51	242500-CS	71		
8153-10-ORG	67	9068-02	72	92026	51	25456855	72		
8154-00-ORG	67	9068-03	72	92027	51	AL24A	56		
8154-10-ORG	67	9500-01	72	92031	51	AL24M	56		
8154-11-ORG	67	9500-02	72	92032	51	AL32A	56		
8154-12-ORG	67	9500-13	72	92041	51	AP-10PK	15		
8157-01-ORG	68	9500-17	72	92042	51	ATI010972-50	60		
8160-00-ORG	68	24750-CS	71	92043	51	ATI010983	60		
8160-20-BLK	68	70014-6	48	92046	51	ATI991340-02	59		
8162-00-ORG	67	70014-7	48	92047	51	ATI991340-09	59		
8162-20-BLK	68	90004	50	92048	51	ATI991346-02	59		
8166-01-ORG	68	90009	50	98010	50	ATI991360-02	59		
8170-00-ORG	68	90014	50	98011	50	ATI991364-02	59		
8180-20-ORG	68	90022	50	98012	50	ATI991370-02	59		
8265-42-FLY	63	90024	50	98013	50	ATI991370-09	59		
8265-42-FOR	63	90026	50	98014	50	ATI991376-02	59		
8265-46-FLY	63	90180	53	98015	50	ATI991604	60		
8265-46-FOR	63	90181	53	98016	50	ATI993600-09	58		
8265-50-FLY	63	90182	53	98017	50	ATI993640-09	58		
8265-50-FOR	63	90520	53	98020	50	ATI994000-09	58		
8265-54-FLY	63	90550	42	98021	50	D10694-T	70		
8265-54-FOR	63	90550-S	43	98023	50	D11145	11		
8265-58-FLY	63	90550-WD	42	98024	50	D11232	18		
8265-58-FOR	63	90551	42	98025	50	D11232	18		
8265-62-FLY	63	90551-WD	42	98026	50	D11232	18		
8265-62-FOR	63	90553	42	99000	54	D11233	18		
8265-66-FLY	63	90553-WD	42	99001	54	D11233	18		
8265-66-FOR	63	90557-050	43	99002	54	D11233	18		
8365-42-FLY	63	90558	43	99003	54	D11234	18		

PRODUCT CATEGORY/DESC	PAGE	PRODUCT CATEGORY/DESC	PAGE	PRODUCT CATEGORY/DESC	PAGE	PRODUCT CATEGORY/DESC	PAGE
GNSS Accessories		Tilted Bracket	10	GNSS Quick-Release Triple Mag Mount	14	21 mm Male and Female 5/8 x 11 Adapter for Scanner Sphere	19
GNSS/MC Tripods: Quick Clamp	5	Laptop Bracket	10	GNSS 5/8 x 11 Triple Mag Mount	14	48 mm Male and Female 5/8 x 11 Adapter for Scanner Sphere	19
GNSS/MC Tripods: Screw Clamp	5	Two-Piece GNSS Rover Rod Aluminum	11	GNSS Triple Mag Mount for Trimble R10	14	Carrying Case solo for Scanner Sphere	19
GNSS/MC Tripods: Quick Clamp/Screw Clamp	5	Two-Piece GNSS Rover Rod Carbon Fiber	11	GNSS 5/8 x 11 Tip	14	Cloth cover for the 230 mm for Scanner Sphere	19
Network Adapter fits MPT 1-1/2 x 11-1/2 TPI	5	Wild Prism Adapter	11	GNSS Quick-Release Tip	14	Hard Case and three (3) 230 mm Scanner Spheres	19
Network Adapter fits MPT 2 x 11-1/2 TPI	5	Prism Pole Adapter - Male	11	GNSS Tripod Radio Antenna Kit	14	196 mm HT Tribach Adapter for TX5/FARO3D for Scanner Sphere	19
Network Adapter fits MPT 3-1/2 x 8 TPI	5	Prism Pole Adapter - Female	11	GNSS Quick-Release Tip	14	Quick Release Adapter for Trimble TX5 and Faro Focus 3D for Scanner Sphere	19
Network Adapter fits MPT 5/8 x 11 TPI	5	Double Male Adapter	11	All-Terrain Rover Rod Big Wheel	14	100 mm Scanner Sphere with Magnet	20
Network Adapter 40-minute leveling vial	5	Double Female Adapter	11	Aluminum Rod for Rover	14	5/8 x 11, 72.5 mm HT Adapter with Magnet	20
Radio Antenna Tripod Mast Assembly	6	Delrin 1-inch Pole Claw Clamp Adapter	11	Carbon Fiber Rod for Rover	14	Scanner Sphere Mini Tripod	20
Radio Antenna Tripod Hardwood/Fiberglass	6	Telescopic Carbon Fiber Rover Rods	11	GNSS Satellite Stick XL	14	6 piece 100 mm Sphere Kit includes Soft Case	20
Radio Antenna Tripod Aluminum	6	Snap-Lock Rover Rod Aluminum	12	GNSS Compass	14	3/8 x 16 Tribach Adapter	20
Hands Free One Shoulder Tablet Harness	6	Snap-Lock Rover Rod Carbon Fiber	12	GNSS Tripod Adapter 3-1/2 x 8 to 5/8 x 11	14	Wall Washer Adapter	20
Hands Free Two Shoulder Tablet Harness	6	Quick Change Prism Pole Aluminum	12	GNSS Tripod Adapter 5/8 x 11 to 3-1/2 x 8	14	Magnet with 1/4 x 20 Stud	20
Quick Release Bracket Adapter for Hands Free Tablet Harness	6	Quick Change Prism Pole Carbon Fiber	12	GNSS Tripod Adapter 5/8 x 11F to 1/4 x 20M	14	V-Base with Washer Magnet	20
Pole Clamp: Ball and Socket Tablet	7	Aluminum Pole Series with Locking Pins, Adapter GNSS Model	12			10 piece 100 mm Sphere Kit includes Hard Case	20
Cradles: Claw Ball and Socket	7	Aluminum Pole Series with Locking Pins, Adapter Robotic Model	12	Ground Control		Soft Case for 100 mm Scanner Spheres	20
Pole Clamp: Tablet Quick Release	7	Aluminum Pole Series with Locking Pins, Adapter Wild Prism Pole Adapter	12	Drone Ground Control Targets	15	Pelican Case for 100 mm Spheres	20
Quick Release Claw Cradles	8	Accessories for Robotics Gear For Topcon Users w/ 77 mm Prism	13	Propeller Aeropoint Generation 2	15	Scanner Target, Tilting, 6 B/W	21
Claw Cradle Assembly for TSC7/Ranger7	8	Accessories for Robotics Gear For Leica Users w/86 mm Prism	13			Scanner Target, Adhesive, 150X200mm, B/W, 10pk	21
Ball and Socket Suction Cup	9	Accessories for Robotics Gear Users w/115 mm Prism	13	Vehicle Accessories			
Ball and Socket Tripod Mount	9	Accessories for Robotics Gear Convert Robotics to GNSS Pole	13	GNSS Bracket for Truck	16		
Ball-and-Socket Link	9	Accessories for Robotics Gear For Topcon ATP1/2 with 50 mm Prism	13	GNSS Bracket for Truck Ford F-150 2015 & 2016 models	16		
ATV Ball Clamp	9	Accessories for Robotics Gear 12 inch Open Clamp Bipod	13	UTV Tubular Roll Cage Transporter for GNSS Rods	17		
Ram Ball Clamp Mount	9	360° Robotic Prism Assembly	13	UTV Rectangular Roll Cage Transporter for GNSS Rods	17		
Quick Release Open-Style Clamps (for 1.25-inch OD pole)	9	GNSS Quick-Release Adapter	13	Bracket ATV, TSC7 / Ranger 7	17		
Ball-and-Socket Clamps (for 1.25-inch OD pole)	9	GNSS Quick-Release Adapter (Stainless Steel)	13	Vehicle Plan Holder	17		
Claw Quick Release Clamps (for 1.25-inch OD pole)	9	GNSS Quick-Disconnect Adapter	13				
Quick Release Cradle	9	GNSS Quick-Disconnect Adapter (Stainless Steel)	13	Vials and Levels			
Quick Release Cradle for Leica Pole Bracket	10	GNSS 60 mm Anti-Rotation Quick Release Adapter	14	Vial for TLV™ Locks	18	Robotics and Specialty Prism Poles	
Tripod Data Collector Antenna Brackets	10	GNSS Male 5/8 Adapter	14	Vial for QLV™ Locks	18	Carbon Fiber Robotics Poles	21
Tripod Data Collector Radio Antenna Bracket	10	6 Foot Snap-Lock Radio Antenna Pole	14	Vial for 1.25-inch OD Pole Levels	18	Adjustable Tip Carbon Fiber Pole	21
Tripod Data Collector Hook TSC7 / Ranger 7	10			Vial for 1.50-inch OD Pole Levels	18	Mini Poles	22
Tripod Hook Brackets Designed for Nomad, TSC3/ Ranger 3, Mesa Tesla or Archer 2	10			Heads-Up™ Level 40-minute Vial	18	Swiss-Style QLV Prism Pole	22
				Standard Rod Level	18	Swiss-Style TLV and Twist-Lock Prism Pole	22
				Snap-On Rod Level	18	Quick-Release Telescopic Prism Pole	23
						TLV and Twist-Locking Telescopic Prism Pole	23
				Laser Scanner Accessories			
				100 mm Scanner Sphere	19	Prism Poles and Rods Accessories	
				230 mm Scanner Sphere	19	Quick Change Pole Adapter	23
				Magnet with 5/8 x 11 Stud for Scanner Sphere	19		

PRODUCT CATEGORY/NUMBER	PAGE	PRODUCT CATEGORY/NUMBER	PAGE	PRODUCT CATEGORY/NUMBER	PAGE	PRODUCT CATEGORY/NUMBER	PAGE
Rhino Ruler Waterproof Fiberglass Engineer's Folding Ruler - 10ths / 8ths	52	Rebar Bolt 3/8 x 16 Threads	60	Prism or Range Pole Protective Bag	68	Miscellaneous Field Accessories	
Rhino Ruler Waterproof Fiberglass Engineer's Folding Ruler - 10ths / Metric	52	Rebar Bolt M12 Threads	60	Prism Pole Hard Shell Case	68	17.5 inch blade, includes sheath	72
CMR Series Measuring Ruler	53	Rebar Bolt M8 Threads	60	LR-STD/LR-PRO Carrying Case	68	13 inch blade, includes sheath	72
SubSurface Handheld Magnetic Locators Standard Model	53	Wall/Column Clamps and Brackets		CR-8 ft/2.4m Carrying Case	68	Plumb Bob Cap	72
SubSurface Handheld Magnetic Locators With LCD Meter	53	Wall/Column Bracket for Lasers and Total Stations	60	CR-13/16/20 ft / SVR-17/25 Carrying Case	68	Plumb Bob Point	72
Hard Shell Case for Locators	53	Heavy Duty Instrument Column Clamp	61	Range Pole Case	68	Solid Brass Bob	72
Gopher Pole Wire Installation Tool	53	Heavy-Duty Column Clamp	61	Direct Elevation Rod Bag	68	Sharpeners For Knives, Scissors and Hand Tools	72
Gopher Pole Carrying Case	53	Rotating Laser Column Clamp	61	CMR Series Measuring Ruler Case	68	Stake Tacks 1 LB	72
Stream Gauges, Supplies and Hand Levels		ANSI/ISEA Class Safety Utility Vests		38 inch Lath Carrier	69	Regular Tac Ball	72
Stream Gauge	54	Safety Lighted Utility Vest	62	Wire Stake Flag Bag for 21 in Flags	69	Tac Ball with Clip	72
Mounting Hardware for Stream Gauge	54	SECO Power Bank 5000 mAh	62	Wire Stake Flag Bag for 30 in Flags	69	Marking Pins 11 count	72
Stream Gauges Plate Numbers	55	Safety Utility Vest 8365-Series	63	Heavy-Duty Rhinotek Lath Bag	69	Leather Sheaths for SECO Plumb Bobs	72
2 Power Stadia Hand Level	55	Safety Utility Vest 8265-Series	63	Heavy-Duty Bucket Lath Carrier	69	Cordura Shot Bag	72
Hand Level Case	55	Safety Utility Vest 8068-Series	64	Heavy-Duty 18-inch Bag for Stakes or Rebar	69	Heavy-Duty Center Punch	72
Optical Instruments		Safety Utility Vest 8069-Series	64	Heavy-Duty 18-inch Bag w/ Center Partition	69	Carbide Scriber	72
Magnetic Dampened Auto Level	56	Hydration Backpack, Bags and Cases		36 inch Heavy-Duty Lath or Rebar Bag	69	Gammon Reels 6.5 ft (1.9m)	72
Construction Theodolite	57	Hydration Backpack	65	48 inch Heavy-Duty Lath or Rebar Bag	69	Gammon Reel Refills	72
Construction Theodolite Diagonal Eye Piece	57	Backpack Carrying System	65	Heavy-Duty 24-inch Bag for Stakes or Rebar	69	Bulk Shiners - Flat or Raised	72
Batter Board Clamp	57	Monster Gear Bag	66	Heavy-Duty 24-inch Bag w/ Center Partition	69	Rite in the Rain	
Laser Detectors and Receivers		Surveyor's Gear Bag with Rhinotek Bottom	66	Standard Spray Can Holder	69	Transit Pattern Bound Books	73
Lightning 2 Laser Detector - Yellow	58	Large Controllers Case	66	Standard Spray Can Holder With Accessory Pockets	69	Level Pattern Bound Books	73
Storm Laserometer Receiver - Yellow	58	Heavy-Duty Collapsible Bucket Bag	66	Total Station Case	69	Level pattern Side-stapled Notebook for Tough Conditions	73
Twister Laser Receiver - Yellow	58	Trimble Pathfinder Series Pole Case	66	Small GIS Backpack and Replacement Range Pole	70	Transit pattern Side-stapled Notebook for Tough Conditions	73
Bullseye 5+ Laser Receiver	59	GNSS Rod Cell Phone Case	66	Total Station Backpack	70	Transit pattern Recyclable Side-spiral Notebook	73
Bullseye 3+ Laser Receiver	59	MiFi Hotspot Case	66	Robotics Backpack	70	Field pattern Recyclable Side-spiral Notebook	73
Bullseye Construction Accessories		Construction-Style Tool Pouch	66	Large GIS Backpack with Cam-Lock Antenna Pole	70		
Bullseye Magnetic Mount For Backhoe and Excavator	59	Surveyor's Tool Pouch with Belt	66	Single Prism Bag	70		
Bullseye Magnetic Mount For Flat Back Dozer Blades	59	Heavy-Duty GNSS Tripod Bag	67	Jumbo Triple Prism Bag	70		
Bullseye Receiver cable, straight, 50 ft	60	Radio Antenna / Elevated Tripod Carrying Case	67	Triple Prism Bag	70		
Bullseye Machine power cable, lighter adapter, 2-8 ft	60	Collapsible GNSS Antenna Tripod Bag	67	Tribrach Case	70		
Bullseye Universal battery charger with wall plugs	60	Extra-Large Antenna / Elevated Tripod Carrying Case	67	Super Jumbo Padded Bag	70		
		GPS Rover Rod Carrying Case	67	Tall Triple Prism Bag	70		
		Heavy-Duty Snap-Lock 2-Meter Pole System Bag	67	Magnetic Nails			
		Heavy-Duty Tripod Bag with Rhinotek Bottom	67	Chrisnik MagNails	71		
		Super-Duty Tripod Bag	67	Chrisnik MagSpikes	71		
		GNSS Rover Rod Hard Shell Case	68	Chrisnik MagHubs	71		
		Heavy-Duty Prism Pole Bipod/Tripod Bag	68	Flagging Dispenser			
		Long Padded System Bag	68	Padded Flagging Dispenser	71		



<https://www.monsenengineering.com/>